





ALL DIVERS SHOULD PROTECT THE WATERS THEY SWIM AND HUNT IN, ENSURING FUTURE DIVERS THE EXPERIENCE AND EXCITEMENT OF FREEDIVING THAT I'VE HAD OVER THE PAST SIXTY-EIGHT YEARS.

SELECTIVE DIVERS SET THEIR SITES ON THOSE FEW PRIZE FISH FOR CONSUMPTION. BE SELECTIVE, FISH FOR THE FUTURE.

I STRIVE TO PRODUCE ONLY THE BEST SPEARFISHING & DIVING EQUIPMENT CAPABLE OF HANDLING ANY CONDITION.

JAY RIFFE
FOUNDER / PRESIDENT / SPEARO
RIFFE INTERNATIONAL, INC.





- SPEARGUNS 6
- METAL TECH ACCESSORIES 23
- POLE SPEARS 26
- SPEARSHAFTS, TIPS, & SLIDE RINGS 30
- REELS & LINE 34
- SPEARGUN KITS 37
- SPEARGUN PARTS & ACCESSORIES 38
- POWER BANDS, SHOOTING LINE & CRIMPS 40
- KNIVES 42
- FLOAT SYSTEMS & ACCESSORIES 44
- MASKS & SNORKELS 48
- FINS 56
- FIN SOCKS & GLOVES 57
- WETSUITS & LYCRAS 58
- GEAR BAGS 62
- APPAREL 67

ENCLOSED TRACK EURO



NEW ENCLOSED TRACK EURO SERIES

Riffe's unparalleled Low Profile EURO designed speargun is now available with an ENCLOSED TRACK. The laminated teak series is manufactured in a rectangular shape with radius corners for maximum beam strength. The enclosed track eliminates shaft whip when firing and gives you more accuracy. IDEAL for FREE-SHAFTING and is very effective when using smaller shafts and more powerful bands. All models come standard with threaded stainless steel reel inserts for mounting a reel.

E-100ET, E-100XET, E-110ET, E-110XET, E-120ET, E-120XET, E-130ET

FEATURES:

- Low-Profile, 3 vertical laminated teak stock
- RIFFE's Stainless Steel 2-Piece Trigger Mechanism with added silencer
- Side rotating spring loaded safety
- Comes standard with 9/32" (7.1mm) Hawaiian flopper Euroshaft
- (2) 5/8" (16mm) black coated amber RIFFE Gorilla Rubber power bands with 1000 lb. Spectra wishbone line (accepts (3) 9/16" (14mm), (2) 5/8" (16mm) or (2) 3/4" (19mm) power bands)
- 5" Bungee Shock Chord with 500 lb. test Pigtail Swivel
- Models E-55 thru E-110x rigged with 250 lb. abrasion resistant Nylon monofilament shooting line for faster shots
- Models E-110 thru E-130 rigged with 300 lb. abrasion resistant Nylon monofilament shooting line for faster shots
- Automatic side mounted line release
- Reinforced bolted muzzle

- Heavy-duty reinforced glass filled Nylon handle with over molded cushion grip
- Rear loading pad with full vision when aiming down the shaft
- Built in threaded reel inserts, designed to fit the RIFFE Horizontal Reel - Flat mount

Optional Setups:

- Threaded Euro shafts available in 17/64" (6.75mm), 9/32" (7.1mm) with Large shark fin tab
- Spearheads sold separately
- 400 lb. 5" Bungee Snap Swivel
- RIFFE Horizontal Reel

All models may be rigged to customer's preference when ordering. See page 24 for all models' specs



EURO X models feature a 5" (12.5cm) rear stock extension for ease of hip loading and aids in faster swing. 100X, 110X, and 120X.



EURO SERIES Designed for all level of divers. Featuring the Mag-Track which offers a faster shaft engagement and may be used for free shafting. RIFFE's low-profile designs are made with 3 vertical laminated teak strips and bolted front muzzle for added strength. The Euro Series gun barrels are manufactured in a rectangular shape with radius corners for maximum beam strength. All models come standard with threaded stainless steel reel inserts for mounting a reel. Models E110X and larger have blue water capabilities.



Michael Takach / Mu

FEATURES:

- Low-Profile, 3 vertical laminate teak stock
- Models E-90x up to E-130 have a thicker stock for increased strength
- RIFFE's Stainless 2-Piece Steel Trigger Mechanism with added silencer
- Side rotating spring loaded safety
- Models E-55 up to E100x standard with 17/64" (6.75mm) Hawaiian flopper Euroshaft
- Models E-110 up to E-130 standard with 9/32" (7.1mm) Hawaiian flopper Euroshaft
- (2) 5/8" (16mm) black coated amber RIFFE Gorilla Rubber power bands with 1000 lb. Spectra wishbone line (accepts (3) 9/16" (14mm), (2) 5/8" (16mm) or (2) 3/4" (19mm) power bands)
- Models E-55 up to E-110x rigged with 250 lb. abrasion resistant Nylon monofilament shooting line for faster shots
- Models E-110 up to E-130 rigged with 300 lb. abrasion resistant Nylon monofilament shooting line for faster shots

- 5" Bunge Shock Chord with 500 lb. test Pigtail Swivel
- Automatic side mounted line release
- Reinforced bolted muzzle
- Heavy-duty reinforced glass filled Nylon handle with over molded cushion grip
- Rear loading pad with full vision when aiming down the shaft
- Built in threaded reel inserts, designed to fit the RIFFE Horizontal Reel - Flat mount

Optional Setups:

- Threaded Euro shafts
- Spearheads sold separately
- 400 lb. 5" Bunge Snap Swivel
- RIFFE Horizontal Reel

All models may be rigged to customer's preference when ordering. See page 24 for all models' specs



EURO X models feature a 5" (12.5cm) rear stock extension for ease of hip loading and aids in faster swing. 90X, 100X, 110X, and 120X.



COMPETITOR TEAK SERIES

Designed for both **entry-level** and **advanced** divers. Most suitable for hunting around reefs, holes, and bottom diving. Models C3S, C3XS, C4S and C4XS have blue water hunting capabilities with proper upgrades.

The Competitor Series has 3 teak laminates. Models C4 & C4X has 4 laminates for added strength. Comes with reinforced muzzle (optional upgrade to a bolted muzzle). A Rest tab may be added for ease of loading and lower power shooting around rocks.

FEATURES:

- Laminate Teak wood stock
- RIFFE's Stainless Steel 2-Piece trigger mechanism assembly, accepts all diameter shafts: 1/4" (6.5mm), 9/32" (7.1mm), 5/16" (8mm), 11/32" (8.7mm), 3/8" (9.5mm)
- Side rotating spring loaded safety
- 9/16" (14mm) black coated amber RIFFE Gorilla Rubber power bands with 1000 lb. Spectra Wishbone line
- 5" Bungie Shock Chord with 500 lb. test Pigtail Swivel
- Rigged with 300 lb. abrasion resistant Nylon monofilament shooting line for faster shots
- Automatic side mounted line release
- Reinforced muzzle
- Heavy-duty ABS Plastic Handle
- Contoured red urethane butt end for comfortable loading

• **Hawaiian Flopper Setup:** Hawaiian or Tahitian Flopper Shaft, 1 wrap of line and 2 power bands for close range shooting; (3) power bands for (2) wraps of line

• **Standard Setup (S) Models:** 5/16" (8mm) Threaded Shaft, 2-Barbed Tip, (2) wraps of line and (3) power bands for long range shooting (tip upgrade available)

Hawaiian & Standard setups are rigged to customer's preference (when purchased)

Optional Setups:

- Rest tab for ease of loading and lower shooting power around rocks
- 5/8" (16mm) bands for more hitting power on longer shafts
- 400 lb. 5" Bungie Snap Swivel
- 400 lb. Monofilament line for heavier shafts
- Bolted reinforced muzzle
- All Models rigged to customer's preference (when purchased)

Accepts all suitable RIFFE parts and accessories. All models may be rigged to customer's preference when ordering. See page 24 for all models' specs.



COMPETITOR X models feature a 3" (7.5cm) rear stock extension for ease of hip loading.



COMPETITOR PADAUK SERIES spearguns are an exact replica of our famous Competitor Teak Series with exception of the wood. We have replaced the teak stock with an African hardwood, commonly known as Padauk. When using a dense, straight grain hardwood such as Padauk we are able to produce the speargun barrels by eliminating the lamination process and maintain straightness.

Similar to the Competitor Series, the Padauk Series is designed for **entry-level** and **advanced divers**, most suitable for hunting around reefs, holes, and on the bottom. Models #3S and #3XS have blue water hunting capabilities with proper upgrades. A Rest Tab may be added for ease of loading and for lower power shooting around rocks.

FEATURES:

- Solid Padauk wood stock
- RIFFEs Stainless Steel 2-Piece trigger mechanism assembly, accepts all diameter shafts: 1/4" (6.5mm), 9/32" (7.1mm), 5/16" (8mm), 11/32" (8.7mm), 3/8" (9.5mm)
- Side rotating spring loaded safety
- 9/16" (14mm) black coated amber RIFFE Gorilla Rubber power bands with 1000 lb. Spectra Wishbone line
- 5" Bungie Shock Chord with 500 lb. test Pigtail Swivel
- Rigged with 300 lb. abrasion resistant Nylon monofilament shooting line for faster shots
- Automatic side mounted line release
- Reinforced muzzle
- Heavy-duty ABS Plastic Handle
- Contoured red urethane butt end for comfortable loading

- **Hawaiian Flopper Setup:** Hawaiian or Tahitian Flopper Shaft, 1 wrap of line and 2 power bands for close range shooting; (3) power bands for (2) wraps of line

- **Standard Setup (S) Models:** 5/16" (8mm) Threaded Shaft, 2-Barbed Tip, (2) wraps of line and (3) power bands for long range shooting (tip upgrade available)

Hawaiian & Standard setups are rigged to customer's preference (when purchased)

Optional Setups:

- Rest tab for ease of loading and lower shooting power around rocks
- 5/8" (16mm) bands for more hitting power on longer shafts
- 400 lb. 5" Bungie Snap Swivel
- 400 lb. abrasion resistant Nylon monofilament shooting line for heavier shafts
- Bolted reinforced muzzle
- All Models rigged to customer's preference (when purchased)

Accepts all suitable RIFFE parts and accessories. All models may be rigged to customer's preference when ordering. See page 24 for all models' specs.



PADAUK X models feature a 5" (12.7cm) rear stock extension for ease of hip loading. 2" (5cm) longer than teak models



STANDARD SERIES

Designed for **all skill levels** and dive conditions. Hand crafted with a heavy-duty 4 laminate teak stock with reinforced muzzle. Each model features a 3" (7.5cm) rear stock extension for ease of hip loading.

Models #3, #4 and #5 are suitable for blue water hunting.

FEATURES:

- Heavy-duty 4 laminate teak stock with side machined grooves for ease of handling
- RIFFE's Stainless Steel 2-Piece trigger mechanism assembly accepting all diameter shafts: 1/4" (6.5mm), 9/32" (7.1mm), 5/16" (8mm), 11/32" (8.7mm), 3/8" (9.5mm)
- Side rotating spring loaded safety
- 5/16" (8mm) threaded shaft with large replaceable 2-Barbed spearhead (tip upgrade available)
- Models #1, #2, #3 have (3) 9/16" (14mm) RIFFE Gorilla Rubber black coated amber power bands
- Models #4 and #5 have (3) 5/8" (16mm) RIFFE Gorilla Rubber black coated amber power bands and additional bolt through muzzle for added reinforcement when using (4) or more bands
- 5" Bungee Shock Chord with 500 lb. test Pigtail Swivel
- Rigged with 300 lb. abrasion resistant Nylon monofilament shooting line for faster shots

- Automatic side mounted line release
- Wedged reinforced muzzle for increased power strength
- Heavy-duty reinforced glass filled Nylon handle with over molded cushion grip
- Larger contoured red urethane Butt End for comfortable hip loading

Optional Setups:

- 5/8" (16mm) power band for more power
- 400 lb. 5" Bungee Snap Swivel
- 500 lb. S.S. cable
- Bolted reinforced muzzle (optional for models #1,#2,#3)

Accepts all suitable RIFFE parts and accessories.
All models may be rigged to customer's preference when ordering.
See page 24 for all models' specs.



MID-HANDLE SERIES spearguns offer more maneuverability when tracking game. Primarily a stomach loading speargun (Optional Rest tab for hip loading).

The Mid Handle models are the most desirable for close bottom and Blue Water hunters alike.

Recommend using two hands for larger models to reduce recoil for accurate shooting. Models #H and larger are spearguns of choice for the serious Blue Water hunters who pursue the large open water pelagic fish.

FEATURES:

- Heavy-duty 4 laminate teak stock with side machine grooves for ease of handling
- RIFFE's Stainless Steel 2-Piece trigger mechanism assembly accepting all diameter shafts: 1/4" (6.5mm), 9/32" (7.1mm), 5/16" (8mm), 11/32" (8.7mm), 3/8" (9.5mm)
- Locking-pin safety
- 5/16" (8mm) threaded shaft with large replaceable 2-Barbed spearhead (tip upgrade available)
- Models #B thru #N standard with (3) 9/16" (14mm) RIFFE Gorilla Rubber black coated amber power bands (may upgrade to 5/8" (16mm) bands for more hitting power)
- Models #I and larger standard with 5/8" (16mm) RIFFE Gorilla Rubber black coated amber bands
- #W standard with (4) 5/8" (16mm) RIFFE Gorilla Rubber black coated amber power bands, 11/32" (8.7mm) threaded shaft, Rest Tab, Ice Pick Slip Tip and Breakaway Setup (recommend 500 lb. S.S. coated cable upgrade) (5th band optional)

- #WE standard with (4) 5/8" (16mm) RIFFE Gorilla Rubber black coated amber power bands (5th band optional), 11/32" (8.7mm) threaded shaft, Rest Tab, Ice Pick Slip Tip, Breakaway Setup with 750lb. S.S. 7x7 5/64" (2mm) uncoated cable rigging, Enclosed Track, Full Body balanced weighted solid padauk wings
- 5" Bungee Shock Chord with 500 lb. test Pigtail Ball Bearing Swivel
- Models #B thru #I rigged with 300 lb. abrasion resistant Nylon monofilament shooting line for faster shots (400lb. recommended on heavier shafts). Model #W standard with 400 lb. abrasion resistant monofilament. S.S. Cable is available as upgrade.
- All models include reinforced teak wedges for added muzzle strength
- Models #I and larger have a bolt through muzzle for added reinforcement when using 4 or more bands (optional on other models)
- Heavy-duty reinforced glass filled Nylon handle with over molded cushion grip

- Large contoured red urethane butt end assembly for comfortable hip & stomach loading

Optional Setups:

- Rest tab recommended on models #H and larger for ease of loading and close shooting
- 400 lb. 5" Bungee Snap Swivel

Accepts all suitable RIFFE parts and accessories. All models may be rigged to customer's preference when ordering. See page 24 for all models' specs.

NOTE: More powerful models must be fired with both hands to prevent injury from excess recoil and maintain accuracy.

BLUE WATER ELITE



BLUE WATER ELITE R-1060

The Ultimate Blue Water Speargun for landing World Record pelagic fish. Evenly balanced, Mid Handle Speargun designed to support the power bands on a parallel plane for maximum power. **The Blue Water Elite model is the #1 speargun of choice for those sought after world record catches.**

The full body weighted Padauk wings create an even balance throughout the stock. Replaceable polyethylene enclosed track for accurate shooting at a distance.

FEATURES

- Heavy-duty 4 laminate teak stock with side machine grooves for ease of handling
- RIFFE's Stainless Steel 2-Piece trigger mechanism assembly accepting all diameter shafts: 1/4" (6.5mm), 9/32" (7.1mm), 5/16" (8mm), 11/32" (8.7mm), 3/8" (9.5mm)
- Locking-pin safety
- Polyethylene replaceable Enclosed Track
- Rigged with an 11/32" (8.7mm) x 65" (165cm) threaded shaft, Rest Tab, Ice Pick Slip Tip w/ Tandum Slide
- (4) 5/8" (16mm) black coated amber power bands
- 750 lb. S.S. 7x7 5/64" (2mm) uncoated cable, Breakaway setup
- Bolted reinforced muzzle
- Heavy-duty reinforced glass filled Nylon handle with over molded cushion grip
- Large contoured red urethane butt end assembly for comfortable hip & stomach loading

Optional Setups:

- Line options available upon request
- Added 5th 5/8" (16mm) power band

May be rigged to customer's preference when ordering. See page 24 for all models' specs.



Brandon Wahlers / Dogtooth Tuna

ISLAND ELITE



ISLAND ELITE R-1048

The Ultimate Blue Water Speargun primarily for hunting pelagic fish. 6" shorter than the Blue Water Elite, the Island Elite is evenly balanced and designed to support the power bands on a parallel plane for maximum power.

The full body weighted Padauk wings create an even balance throughout the stock. Replaceable polyethylene enclosed track for accurate shooting at a distance.

FEATURES

- Heavy-duty 4 laminate teak stock with side machine grooves for ease of handling
- RIFFE's Stainless Steel 2-Piece trigger mechanism assembly accepting all diameter shafts: 1/4" (6.5mm), 9/32" (7.1mm), 5/16" (8mm), 11/32" (8.7mm), 3/8" (9.5mm)
- Locking-pin safety
- Polyethylene replaceable Enclosed Track
- Rigged with an 11/32" (8.7mm) x 65" (165cm) threaded shaft, Rest Tab, Ice Pick Slip Tip w/ Tandum Slide
- (4) 5/8" (16mm) black coated amber power bands
- 750 lb. S.S. 7x7 5/64" (2mm) uncoated cable, Breakaway setup
- Bolted reinforced muzzle
- Heavy-duty reinforced glass filled Nylon handle with over molded cushion grip
- Large contoured red urethane butt end assembly for comfortable hip & stomach loading

Optional Setups:

- Line options available upon request
- Added 5th 5/8" (16mm) power band

May be rigged to customer's preference when ordering. See page 24 for all models' specs.



Ryder Devoe / wahoo



METAL TECH SERIES are the spearguns of choice for scuba divers wanting a mid-handle type speargun in severe conditions. Larger models are the preferred choice for blue water hunting. The setup and shape is similar to our teak Mid-Handle Series with exception of its uniquely designed heavy-duty, heat treated aluminum extruded gun barrel offering zero deflection with maximum power.

RIFFE Metal Tech spearguns have an added silencer in the line release and a polyethylene shaft slider making this a truly silent speargun. The textured handle is over-molded with softer material for comfort. All stainless steel components have been specially treated to prevent corrosion.



Rear Handle Metal Tech
Models MTR-4 and MTR-5 feature a low-profile barrel to increase flotation and ease of swinging through the water.

METAL TECH FEATURES: MID and REAR Handle Series

- Heavy-duty heat treated aircraft aluminum gun barrel with black hard anodized finish for long life in sea water with stealth appearance
- All Metal Tech spearguns are filled with high density foam
- RIFFE's Stainless Steel 2-Piece trigger mechanism assembly
- Locking-pin safety
- Polyethylene shaft slider (open or closed track) and two vinyl silencers in the mechanism produce extremely quiet shooting. Replacement track available in all lengths.
- Models #0, #1, #2 & #3 come with 9/16" (14mm) RIFFE Gorilla Rubber black coated amber bands rigged with 250 lb. abrasion resistant Nylon monofilament shooting line for faster shots.
- Metal Tech #4, #5 & #6 standard with 5/8" (16mm) RIFFE Gorilla Rubber black coated amber bands rigged with 300 lb. abrasion resistant Nylon monofilament shooting line for faster shots.

- 5" Bungee Shock Chord with 500 lb. test Pigtail Swivel
- Metal Tech #5 and #6 come with Rest Tabs
- Heavy duty reinforced, glass filled Nylon muzzle accepting up to (4) 9/16" (14mm) or (3) 5/8" (16mm) bands
- Heavy duty, reinforced glass filled Nylon handle with over molded cushion grip
- Rear handle Metal Tech models are pre-drilled to accept a Horizontal Radial Mount Reel

• **Hawaiian Setup:** Hawaiian (top) or Tahitian (bottom) Flopper Shaft, 1 wrap of line and 2 power bands for close range shooting. (optional 2 wraps with extra band)

• **Standard Setup (S):** Threaded Shaft, 2-Barbed Tip, 2 wraps of line and 3 power bands for long range shooting (Upgrade tips optional)

Optional Setups:

- Aluminum Muzzle, accepting up to (6) 9/16" (14mm) or (4) 5/8" (16mm) bands
- 400 lb. 5" Bungee Snap Swivel
- A Rest Tab is recommended for ease of loading and close range shooting on #3 and larger spearguns
- 400 lb. abrasion resistant Nylon monofilament shooting line or S.S. Cable for heavier spearshafts

Accepts most all RIFFE parts and accessories. See pg. 24 for all specification on models.

NOTE: More powerful models must be fired with both hands to prevent injury from excess recoil and maintain accuracy.



MACH 4 (M-1050M) & MACH 5 (M-1060M)

RIFFE Mach 4 & 5 Metal Tech REAR handle low profile speargun modified for blue water hunting pelagic fish.

Features full length tapered Padauk wings for mass and floatation to give an even balance throughout the stock. Equipped with a polyethylene enclosed track for accurate shooting. Comes standard with threaded holes for the Horizontal Radial Mounted Reel.

- Heavy-duty heat treated aircraft aluminum gun barrel with black hard anodized finish for long life in sea water with stealth appearance
- All Metal Tech spearguns are filled with high density foam
- Full length tapered Padauk wings
- RIFFE's Stainless Steel 2-Piece trigger mechanism assembly
- Locking-pin safety
- Polyethylene shaft slider (open or closed track) and two vinyl silencers in the mechanism produce extremely quiet shooting.

Replacement track available in all lengths.

- Rigged with 5/16" (8mm) x 60" (152cm) threaded shaft, Rest Tab, 5/16" (8mm) Ice Pick Slip Tip w/ tandem slide
- (3) 5/8" (16mm) RIFFE Gorilla Rubber black coated amber bands
- 400 lb. abrasion resistant Nylon monofilament shooting line for faster shots
- Breakaway set up
- Heavy duty reinforced, glass filled Nylon muzzle accepting up to (4) 9/16" (14mm) or (3) 5/8" (16mm) bands
- Heavy duty, reinforced glass filled Nylon handle with over molded cushion grip

Optional Setups:

- 500 lb. 1/16" 7x7 coated or uncoated cable
- Reel may be added
- Aluminum Muzzle (use with 4 bands for more power)
- Power band sizes
- Accepts 9/32" or 5/16" flopper spearshafts

Accepts most all RIFFE parts and accessories. See pg. 24 for all specification on models.



Glass Filled Nylon Muzzle (M-7050)

Designed for the Metal Tech Series speargun and comes stock. Fits up to (3) 5/8" (16mm) or (4) 9/16" (14mm) power bands.

Aluminum Muzzle (M-7060)

Black heat cured finish cast Aluminum Muzzle is designed for the Metal Tech Series to allow increased power using (4) 5/8" (16mm) or (6) 9/16" (14mm) power bands. Front Floater Wing Kit is recommended for added buoyancy

**Note: Spearguns will be negatively buoyant without Front Floater Wings or Teak Ballast Wing Kits.



Vertical Reel Mounting Bracket (RL-1006)

For Metal Tech Series (sidemount) only

Enclosed Track Kit (ETR-00) Upgrade

Designed for Free Shafting on Metal Tech Series speargun only. Kit available for existing Riffe Metal Tech speargun models. Accepts 9/32" (7.1mm) or 5/16" (8mm) spearshafts.



High Density Front Floater Wing Kit (K-5500)

Made of 24 lb. high density foam molded polyurethane. Designed primarily for the Metal Tech Series speargun to add buoyancy and stabilize shooting with parallel pull. Floats models #3 thru #5 without shaft. For added floatation we recommend using with Rear Teak Ballast Wing Kit (K-6500).

PART #	MODEL	STOCK LENGTH*	SHAFT / TIP (Hawaiian or Tahitian)		POWERBAND			SHOOTING RANGE				
			Shaft Diameter x Length	Tip Style	Qty	Diameter	Length		Stretch**			
E-100ET	Euro 100 Enclosed Track	52" (132cm)	9/32" (7.1mm)	Hawaiian Flopper	2	5/8" (16mm)	24" (61cm)	40.5" (103cm)	20' (6.1m)			
E-100XET	Euro 100X Enclosed Track	54" (137cm)					55" (140cm)	24" (61cm)	40.5" (103cm)	20' (6.1m)		
E-110ET	Euro 110 Enclosed Track	54" (137cm)					59" (150cm)	26.5" (67cm)	44.5" (113cm)	22' (6.7m)		
E-110XET	Euro 110X Enclosed Track	58" (147cm)					59" (150cm)	26.5" (67cm)	44.5" (113cm)	22' (6.7m)		
E-120ET	Euro 120 Enclosed Track	58" (147cm)					63" (160cm)	29.5" (75cm)	48.5" (123cm)	24' (7.3m)		
E-120XET	Euro 120X Enclosed Track	62" (157cm)					63" (160cm)	29.5" (75cm)	48.5" (123cm)	24' (7.3m)		
E-130ET	Euro 130 Enclosed Track	62" (157cm)					67" (170cm)	32" (81cm)	52.5" (133cm)	26' (8m)		
RC-0000	Competitor #00	28" (71cm)	9/32" (7.1mm)	Hawaiian Flopper	2	9/16" (14mm)	12" (30.5cm)	16" (41cm)	5.5' (1.68m)			
RC-0001	Competitor #00S	28" (71cm)		26" (66cm)	Threaded (6mm thrd) / Med Head		3	12" (30.5cm)	16" (41cm)	8' (2.44m)		
RC-0002	Competitor #0	34" (86.4cm)		34" (86cm)	Hawaiian Flopper		2	15" (38cm)	22" (56cm)	7.5' (2.29m)		
RC-0003	Competitor #0S	34" (86.4cm)		32" (81cm)	Threaded (6mm thrd) / Med Head		3	15" (38cm)	22" (56cm)	11' (3.35m)		
RC-0004	Competitor #1	40" (101.6cm)		44" (112cm)	Hawaiian Flopper		2	18" (46cm)	28" (71cm)	9.5' (2.9m)		
RC-0005	Competitor #1S	40" (101.6cm)		5/16" (8mm)	Threaded (24" thrd) / Lrg Head		3	18" (46cm)	28" (71cm)	14' (4.27m)		
RC-0006	Competitor #2	46" (116.8cm)		9/32" (7.1mm)	Hawaiian Flopper		2	20" (51cm)	34" (86cm)	11.5' (3.51m)		
RC-0007	Competitor #2S	46" (116.8cm)	5/16" (8mm)	Threaded (24" thrd) / Lrg Head	3	20" (51cm)	34" (86cm)	17' (5.18m)				
RC-0008	Competitor #2X	48" (122cm)	9/32" (7.1mm)	Hawaiian Flopper	2	20" (51cm)	34" (86cm)	11.5' (3.51m)				
RC-0009	Competitor #2XS	48" (122cm)	5/16" (8mm)	Threaded (24" thrd) / Lrg Head	3	20" (51cm)	34" (86cm)	17' (5.18m)				
RC-0010	Competitor #3	52" (132cm)	9/32" (7.1mm)	Hawaiian Flopper	2	24" (61cm)	40" (102cm)	13.5' (4.11m)				
RC-0011	Competitor #3S	52" (132cm)	5/16" (8mm)	Threaded (24" thrd) / Lrg Head	3	24" (61cm)	40" (102cm)	20' (6.10m)				
RC-0012	Competitor #3X	55" (139.7cm)	9/32" (7.1mm)	Hawaiian Flopper	2	24" (61cm)	40" (102cm)	13.5' (4.11m)				
RC-0013	Competitor #3XS	55" (139.7cm)	5/16" (8mm)	Threaded (24" thrd) / Lrg Head	3	24" (61cm)	40" (102cm)	20' (6m)				
RC-0014	Competitor #4	58" (147.3cm)	9/32" (7.1mm)	Hawaiian Flopper	2	26" (66cm)	46" (117cm)	15.5' (4.75m)				
RC-0015	Competitor #4S	58" (147.3cm)	5/16" (8mm)	Threaded (24" thrd) / Lrg Head	3	26" (66cm)	46" (117cm)	23' (7m)				
RC-0016	Competitor #4X	61" (154.9cm)	9/32" (7.1mm)	Hawaiian Flopper	2	26" (66cm)	46" (117cm)	15.5' (4.75m)				
RC-0017	Competitor #4XS	61" (154.9cm)	5/16" (8mm)	Threaded (24" thrd) / Lrg Head	3	26" (66cm)	46" (117cm)	23' (7m)				
RCP-0000	Padauk #00	28" (71cm)	9/32" (7.1mm)	Hawaiian Flopper	2	9/16" (14mm)	12" (30.5cm)	16" (41cm)	5.5' (1.68m)			
RCP-0001	Padauk #00S	28" (71cm)					26" (66cm)	Threaded (6mm thrd) / Med Head	3	12" (30.5cm)	16" (41cm)	8' (2.44m)
RCP-0002	Padauk #0	34" (86.4cm)					34" (86cm)	Hawaiian Flopper	2	15" (38cm)	22" (56cm)	7.5' (2.29m)
RCP-0003	Padauk #0S	34" (86.4cm)					32" (81cm)	Threaded (6mm thrd) / Med Head	3	15" (38cm)	22" (56cm)	11' (3.35m)
RCP-0004	Padauk #1	40" (101.6cm)					44" (112cm)	Hawaiian Flopper	2	18" (46cm)	28" (71cm)	9.5' (2.9m)
RCP-0005	Padauk #1S	40" (101.6cm)					5/16" (8mm)	Threaded (24" thrd) / Lrg Head	3	18" (46cm)	28" (71cm)	14' (4.27m)
RCP-0006	Padauk #2	46" (116.8cm)					9/32" (7.1mm)	Hawaiian Flopper	2	20" (51cm)	34" (86cm)	11.5' (3.51m)
RCP-0007	Padauk #2S	46" (116.8cm)	5/16" (8mm)	Threaded (24" thrd) / Lrg Head	3	20" (51cm)	34" (86cm)	17' (5.18m)				
RCP-0008	Padauk #2X	51" (129.5cm)	9/32" (7.1mm)	Hawaiian Flopper	2	20" (51cm)	34" (86cm)	11.5' (3.51m)				
RCP-0009	Padauk #2XS	51" (129.5cm)	5/16" (8mm)	Threaded (24" thrd) / Lrg Head	3	20" (51cm)	34" (86cm)	17' (5.18m)				
RCP-0010	Padauk #3	52" (132cm)	9/32" (7.1mm)	Hawaiian Flopper	2	24" (61cm)	40" (102cm)	13.5' (4.11m)				
RCP-0011	Padauk #3S	52" (132cm)	5/16" (8mm)	Threaded (24" thrd) / Lrg Head	3	24" (61cm)	40" (102cm)	20' (6.10m)				
RCP-0012	Padauk #3X	57" (145cm)	9/32" (7.1mm)	Hawaiian Flopper	2	24" (61cm)	40" (102cm)	13.5' (4.11m)				
RCP-0013	Padauk #3XS	57" (145cm)	5/16" (8mm)	Threaded (24" thrd) / Lrg Head	3	24" (61cm)	40" (102cm)	20' (6.10m)				
R-1005	#1 Bottom	44" (111.8cm)	5/16" (8mm)	Threaded (24" thrd) / Lrg Head	3	9/16" (14mm)	18" (46cm)	28" (71cm)	14' (4.27m)			

PART #	MODEL	STOCK LENGTH	SHAFT & TIP STYLE (Hawaiian or Tahitian)		POWERBAND			SHOOTING RANGE		
			Shaft Diameter x Length	Shaft & Tip Style	Qty	Diameter	Length		Stretch**	
R-1010	#2 Mid Range	50" (127cm)	5/16" (8mm)	Threaded (24" thrd) / Lrg Head	3	9/16" (14mm)	48" (122cm)	20" (51cm)	34" (86cm)	17' (5.18m)
R-1015	#3 Standard	56" (142.2cm)					55" (140cm)	24" (61cm)	40" (102cm)	20' (6.10m)
R-1020	#4 Baja	62" (157.5cm)					60" (152cm)	26" (66cm)	46" (117cm)	23' (7.01m)
R-1025	#5 Baja Plus	68" (172.7cm)					65" (165cm)	28.5" (72cm)	51" (130cm)	26' (7.92m)
R-1030	#B-Bottom	37" (94cm)					42" (107cm)	18" (46cm)	28" (71cm)	14' (4.20m)
R-1035	#M-Mid Range	43" (109.2cm)					48" (122cm)	20" (51cm)	34" (86cm)	17' (5.18m)
R-1040	#H-Hawaiian	49" (124.5cm)					55" (140cm)	24" (61cm)	39" (99cm)	20' (6.10m)
R-1042	#N-No Ka Oi	55" (140cm)	60" (152cm)	26" (66cm)	44" (112cm)	23' (7.01m)				
R-1045	#I-Island	61" (155cm)	65" (165cm)	28.5" (72cm)	50" (127cm)	26' (7.92m)				
R-1048	#IE- Island Elite	61" (155cm)	60" (152cm)	Threaded (24"thrd) / Ice Pick	4	5/8" (16mm)	28.5" (72cm)	50" (127cm)	26' (7.92m)	
R-1050	#W-Blue Water	67" (170cm)	72" (183cm)	32" (81cm)			56" (142cm)	29' (8.84m)		
R-1060	#WE-Blue Water Elite	67" (170cm)	65" (165cm)	32" (81cm)			56" (142cm)	29' (8.84m)		
E-55	Euro 55	34" (86cm)	34" (86cm)	15" (38cm)			22.5" (57cm)	10' (3m)		
E-75	Euro 75	40" (102cm)	45" (115cm)	18" (46cm)	30.5" (77.5cm)	15' (4.6m)				
E-90	Euro 90	46" (117cm)	51" (130cm)	21.5" (55cm)	37" (94cm)	18' (5.5m)				
E-90X	Euro 90X	50" (127cm)	51" (130cm)	21.5" (55cm)	36" (91.5cm)	18' (5.5m)				
E-100	Euro 100	52" (132cm)	55" (140cm)	24" (61cm)	40.5" (103cm)	20' (6.1m)				
E-100X	Euro 100X	54" (137cm)	55" (140cm)	24" (61cm)	39.5" (126cm)	20' (6.1m)				
E-110	Euro 110	54" (137cm)	59" (150cm)	26.5" (67cm)	44.5" (113cm)	22' (6.7m)				
E-110X	Euro 110X	58" (147cm)	59" (150cm)	26.5" (67cm)	43.5" (110.5cm)	22' (6.7m)				
E-120	Euro 120	58" (147cm)	63" (160cm)	29.5" (75cm)	48.5" (123cm)	24' (7.3m)				
E-120X	Euro 120X	62" (157cm)	63" (160cm)	29.5" (75cm)	47.5" (120.5cm)	24' (7.3m)				
E-130	Euro 130	62" (157cm)	67" (170cm)	32" (81cm)	52.5" (133cm)	26' (8m)				
M-0000	Metal Tech #0	32" (81cm)	9/32" (7.1mm)	34" (86cm)	Hawaiian Flopper Shaft	2	15" (38cm)	22" (56cm)	7.5' (2.29m)	
M-0001	Metal Tech #0S	32" (81cm)	5/16" (8mm)	32" (81cm)	Threaded (24"thrd) / Lg Head	3	15" (38cm)	22" (56cm)	11' (3.35m)	
M-1000	Metal Tech #1	38" (96.5cm)	9/32" (7.1mm)	44" (112cm)	Hawaiian Flopper Shaft	2	18" (46cm)	28" (71cm)	9.5' (2.9m)	
M-1005	Metal Tech #1S	38" (96.5cm)	5/16" (8mm)	42" (107cm)	Threaded (24"thrd) / Lg Head	3	18" (46cm)	28" (71cm)	14' (4.27m)	
M-1010	Metal Tech #2	44" (112cm)	9/32" (7.1mm)	50" (127cm)	Hawaiian Flopper Shaft	2	20" (51cm)	34" (86cm)	11.5' (3.51m)	
M-1015	Metal Tech #2S	44" (112cm)	5/16" (7.1mm)	48" (122cm)	Threaded (24"thrd) / Lg Head	3	20" (51cm)	34" (86cm)	17' (5.18m)	
M-1020	Metal Tech #3	50" (127cm)	9/32" (7.1mm)	57" (145cm)	Hawaiian Flopper Shaft	2	24" (61cm)	40" (102cm)	13.5' (4.11m)	
M-1025	Metal Tech #3S	50" (127cm)	5/16" (8mm)	55" (140cm)	Threaded (24"thrd) / Lg Head	3	24" (61cm)	40" (102cm)	20' (6.1m)	
M-1030	Metal Tech #4	56" (142cm)	9/32" (7.1mm)	65" (165cm)	Hawaiian Flopper Shaft	2	26" (66cm)	46" (117cm)	15.5' (4.72m)	
M-1035	Metal Tech #4S	56" (142cm)	5/16" (8mm)	60" (152cm)	Threaded (24"thrd) / Lg Head	3	26" (66cm)	46" (117cm)	23' (7.01m)	
M-1040	Metal Tech #5	62" (157cm)	9/32" (7.1mm)	72" (183cm)	Hawaiian Flopper Shaft / Rest	2	30" (76cm)	52" (132cm)	17.5' (5.33m)	
M-1045	Metal Tech #5S	62" (157cm)	5/16" (8mm)	65" (165cm)	Threaded (24"thrd) / Rest / Lg Head	3	30" (76cm)	52" (132cm)	26' (7.92m)	
M-1046	Metal Tech #6S	68" (173cm)	11/32" (8.7mm)	72" (183cm)	Threaded (24"thrd) / Rest / Ice Pick	3	32" (81cm)	58" (147cm)	29' (8.83m)	
M-1050	Metal Tech #4 (rear handle)	56" (142cm)	9/32" (7.1mm)	65" (165cm)	Hawaiian Flopper Shaft	2	26" (66cm)	46" (117cm)	15.5' (4.72m)	
M-1055	Metal Tech #4S (rear handle)	56" (142cm)	5/16" (8mm)	60" (152cm)	Threaded (24"thrd) / Lg Head	3	26" (66cm)	46" (117cm)	23' (7.01m)	
M-1060	Metal Tech #5 (rear handle)	62" (157cm)	9/32" (7.1mm)	72" (183cm)	Hawaiian Flopper Shaft / Rest	2	30" (76cm)	52" (132cm)	17.5' (5.33m)	
M-1065	Metal Tech #5S (rear handle)	62" (157cm)	5/16" (8mm)	65" (165cm)	Threaded (24"thrd) / Rest / Lg Head	3	30" (76cm)	52" (132cm)	26' (7.92m)	
M-1050M	MACH 4	56" (142cm)	5/16" (8mm)	55" (140cm)	Threaded (24"thrd) / Rest / Ice Pick	3	26" (76cm)	46" (117cm)	23' (7.01m)	
M-1060M	MACH 5	62" (157cm)	5/16" (8mm)	60" (165cm)	Threaded (24"thrd) / Rest / Ice Pick	3	30" (76cm)	52" (132cm)	26' (7.92m)	

** Stock Length is measurement gun stock including Butt End Assembly ** Powerband stretch is measured from inner muzzle slot to the front of mechanism

CARBON FIBER POLE SPEAR

RIFFE Carbon Fiber Pole Spears were designed with versatility for lightning fast shots while still keeping the punch to take down world record fish.

Tapered Javelin style front and back sections provide the best maneuverability in all conditions. Fiberglass reinforced front rod adds strength. Eight sections offered to configure multiple lengths for varying hunting options.

Handle grip is placed on front section. Nose at front end piece has a flat for securing spearshaft and sections.

Recommended tools for assembly: 3/8" (10mm) and 9/16" (14mm) open end wrenches, vice grip pliers for tightening or removing the spearshaft.



6 Foot Pole Spear package (RPS-062)

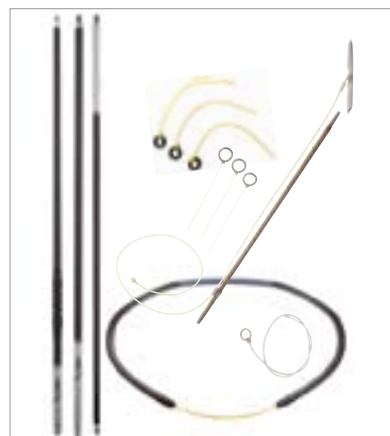

9 Foot Pole Spear package (RPS-093)

Custom build to any length

- a. 4 ft. (1.21 meters)
 - b. 5 ft. (1.52 meters)
 - c. 6 ft. (1.82 meters)
 - d. 6 ft. (1.82 meters)
 - e. 7 ft. (2.13 meters)
 - f. 8 ft. (2.43 meters)
 - g. 9 ft. (2.74 meters)
 - h. 10 ft. (3.04 meters)
 - i. 10 ft. (3.04 meters)
- } 2 pc.
} 3 pc.
} 4 pc.

Available Pole Spear Sections:

- j. 24" (61cm)
 - k. 36" (91.5cm)
 - l. 12" (30.5cm)
 - m. 24" (61cm)
 - n. 36" (91.5cm)
 - o. 48" (122cm)
 - p. 24" (61cm)
 - q. 36" (91.5cm)
- } Tapered Front Section w/ grip
} Straight Mid Section
} Tapered Back Section



Kimi Werner / Grouper / Bahamas
Pole Spear with Extended Breakaway setup

POLE SPEAR PARTS

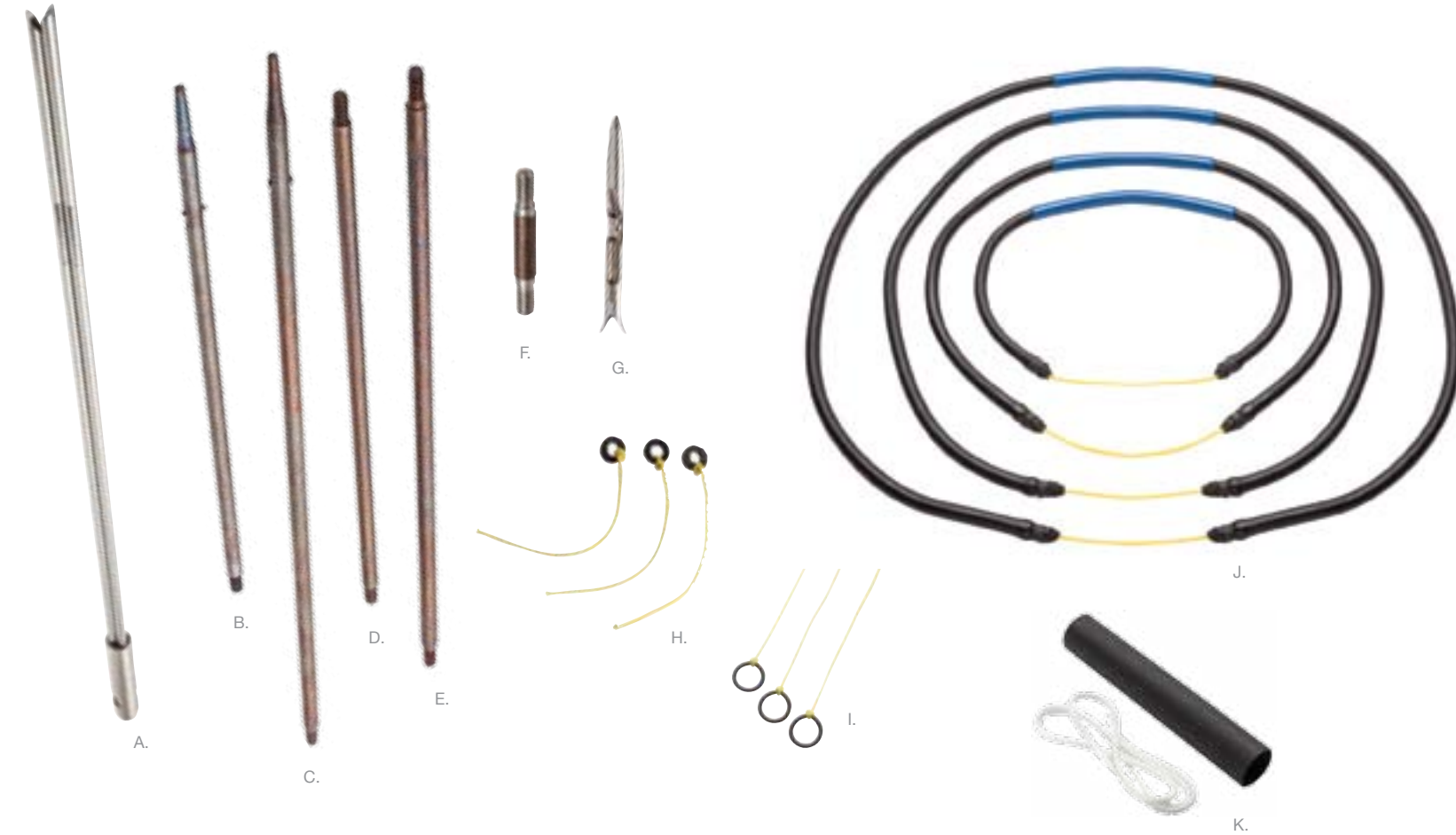

- A.** 3-Prong Pinch Head (Tip only) (RPS-H01T)
- B.** 9/32" (7.1mm) x 10" (25.4cm) Tapered Nose Piece Shaft Adapter (6mm thread) (RPS-A01) / Also available in 9/32" (7.1mm) x 16" (40.5cm) Tapered Nose Piece Shaft Adapter (6mm thread) (RPS-A03 not shown)
- C.** 5/16" (8mm) x 15" (38cm) Tapered Nose Piece Shaft Adapter (6mm thread) (RPS-A02)
- D.** 9/32" (7.1mm) x 10" (25.4cm) Threaded Shaft Adapter (6mm thread both ends) (RPS-3200)
- E.** 5/16" (8mm) x 12" (30.5cm) Threaded Shaft Adapter (6mm thread both ends) (RPS-3205)

- F.** 3-Prong Pinch Head Adapter (Adapter only) (RPS-H01A)
- G.** SUB-Mini Tip (only) (RPS-H02T)
- H.** Rubber Ring Line Assembly for SUB-Mini Ice Pick Tip (3) (RPS-RL01)
- I.** O-ring replacements line keeper (3) for SUB-Mini Ice Pick Tip (3) (RPS-OR1)
- J.** 3/8" (9.5mm) Pole Spear Power Bands with vinyl grip (PP-5000 thru PP-5025)
- K.** Self Adhesive Shrink Tube Grip Assembly (RPS-GR01)



Teflon Tape recommended to secure joints.

POLE SPEAR ASSEMBLIES

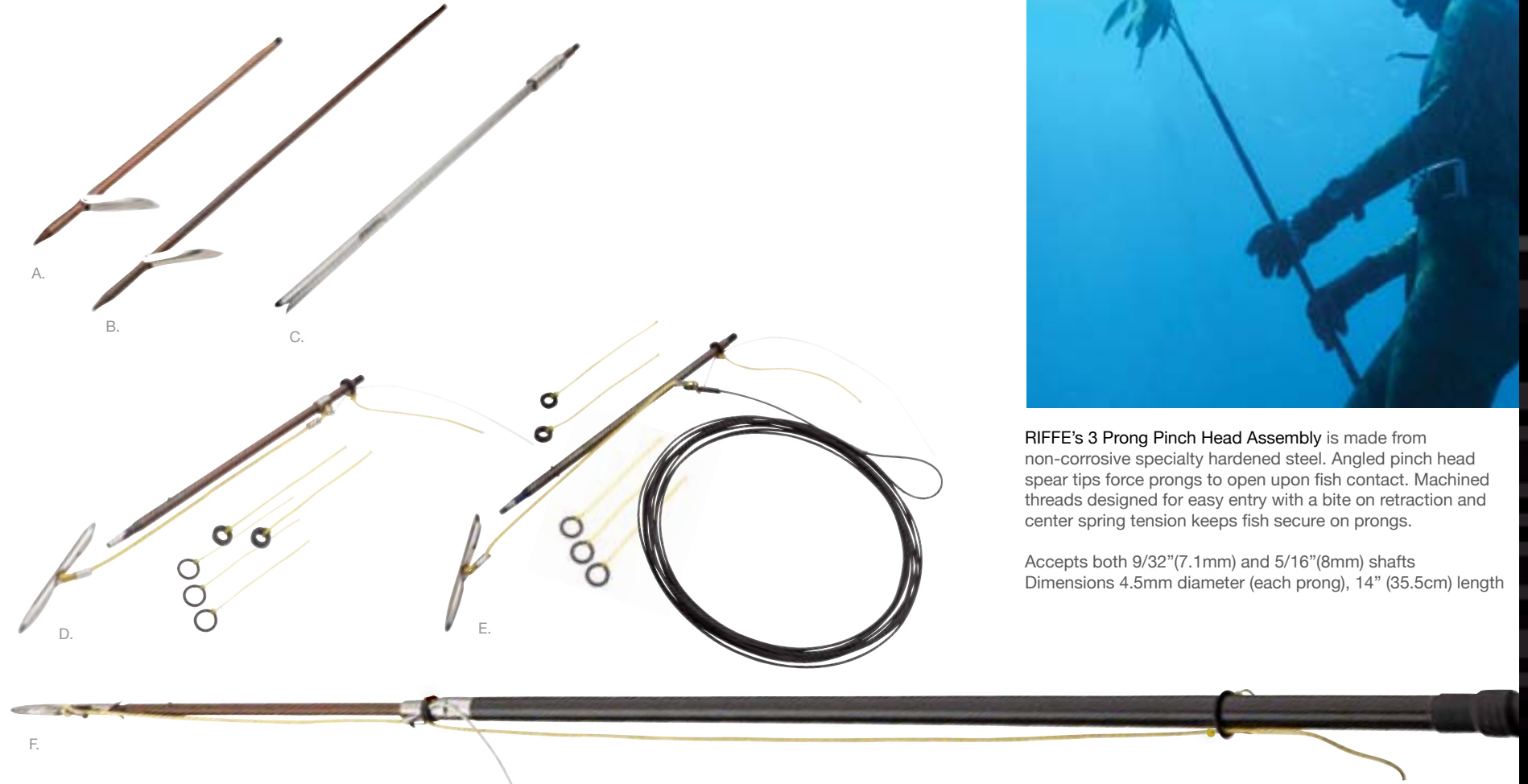

- A.** 9/32" (7.1mm) x 12" (30.5cm) Single Flopper Hawaiian Pole Spear Shaft (RPS-3100)
- B.** 9/32" (7.1mm) x 18" (46cm) Single Flopper Hawaiian Pole Spear Shaft (RPS-3105)
- C.** 3 Prong Pinch Head Assembly (RPS-H01)
- D.** 9/32" (7.1mm) SUB-Mini Ice Pick Tip Assembly (3.25" (8.26cm) long). Includes slide ring and 10" (25.4cm) shaft adapter with stop and 3 1/4 ft (1m) 1000 lb. Spectra line. Extended Breakaway (RPS-H04) (16" (40.5cm) shaft adapter upgrade available)

- E.** 9/32" (7.1mm) SUB-Mini Ice Pick Tip Assembly (3.25" (8.26cm) long). Includes 10" (25.4cm) nose piece shaft adapter with stop, 20 ft. mono line setup, rubber keeper and ring line assembly. Complete Breakaway (RPS-H03)
- F.** 9/32" (7.1mm) SUB-Mini Ice Pick Tip Assembly (3.25" (8.26cm) long). Includes slide ring and 10" (25.4cm) shaft adapter with stop and 3 1/4 ft (1m) 1000 lb. Spectra line. Extended Breakaway (RPS-H04) (16" (40.5cm) shaft adapter upgrade available)

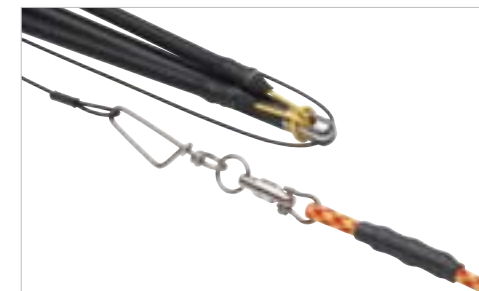

Breakaway setup shown.

RIFFE's 3 Prong Pinch Head Assembly is made from non-corrosive specialty hardened steel. Angled pinch head spear tips force prongs to open upon fish contact. Machined threads designed for easy entry with a bite on retraction and center spring tension keeps fish secure on prongs.

Accepts both 9/32"(7.1mm) and 5/16"(8mm) shafts
Dimensions 4.5mm diameter (each prong), 14" (35.5cm) length

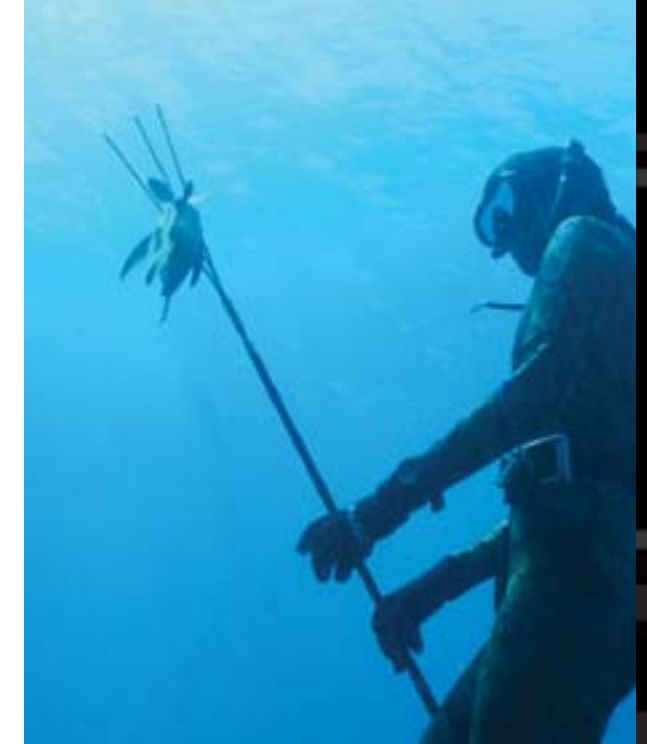

SPEAR SHAFTS

RIFFE American Square Notch Spearshafts are made with spring stainless steel. Heat treated to increase strength and flexibility of shaft memory. Manufactured using computer numerical controlled (CNC) machines, producing precision parts. The original RIFFE-designed shark-fin tabs have a smooth finish capable of holding 1 to 2 power bands per tab. Smaller shafts feature (2) tabs. Shafts 60" and longer (3) tabs. All shaft machined areas are hand finished.

Available diameters:
9/32" (7.1mm), 5/16" (8mm), 11/32" (8.7mm) and 3/8" (9.5mm)

Hawaiian Flopper Shafts
 • 9/32" (7.1mm) Diameter - Lengths: 28" (71cm), 34" (86cm), 44" (112cm), 50" (127cm), 57" (145cm), 65" (165cm), 72" (183cm)
 • 5/16" (8mm) Diameter - Lengths: 44" (112cm), 50" (127cm), 57" (145cm), 65" (165cm), 72" (183cm)

Hawaiian Double Flopper Shafts
 • 5/16" (8mm) Diameter (3 3/16" barb) - Lengths: 57" (145cm), 65" (165cm), 72" (183cm)

Threaded Shafts
 • 9/32" (7.1mm) Diameter - Lengths: 26" (66cm), 32" (81cm), 42" (107cm), 48" (122cm), 55" (140cm), 60" (152cm), 65" (165cm), 72" (183cm)
 • 5/16" (8mm) Diameter - Lengths: 32" (81cm), 42" (107cm), 48" (122cm), 55" (140cm), 60" (152cm), 65" (165cm), 72" (183cm)
 • 11/32" (8.7mm) Diameter - Lengths: 55" (140cm), 60" (152cm), 65" (165cm), 72" (183cm)
 • 3/8" (9.5mm) Diameter - Lengths: 55" (140cm), 60" (152cm), 65" (165cm), 72" (183cm)

Rest Tab - Optional (RT-1000)
 Larger loading tab welded 12" (30.5cm) from rear of shaft for ease of loading or short shots



Loading tab



Rest tab



5/16 x 24 thrd 6mm thrd



Single Flopper



Double Flopper



Rest tab



EURO SHAFTS

RIFFE Heat Treated Spring S.S. Euroshafts are manufactured for all European sling style spearguns. The RIFFE Euroshafts are CNC machined and feature our custom designed Mini Shark-Fin tabs rather than notches.

Shaft options: 6mm thread, Hawaiian (flopper on bottom) or Tahitian (flopper on top). All barbs are heat treated for strength.

Available diameters:
17/64" (6.75mm), 9/32" (7.1mm), and 19/64" (7.5mm)

Hawaiian Flopper Euroshafts
 • 17/64" (6.75 mm) Diameter - Lengths: 34" (86cm), 45" (115cm), 51" (130cm), 55" (140cm), 59" (150cm), 63" (160cm), 67" (170cm)
 • 9/32" (7.1 mm) Diameter - Lengths: 34" (86cm), 45" (115cm), 51" (130cm), 55" (140cm), 59" (150cm), 63" (160cm), 67" (170cm), 71" (180cm)
 • 19/64" (7.5 mm) Diameter - Lengths: 55" (140cm), 59" (150cm), 63" (160cm), 67" (170cm), 71" (180cm)

Hawaiian Double Flopper Shafts
 • 19/64" (7.5mm) Diameter (3 3/16" barb) - Lengths: 59" (150cm), 63" (160cm), 67" (170cm)

NEW Tri-Cut Hawaiian Flopper Shafts
 • 9/32" (7.1 mm) Diameter - Lengths: 55" (140cm), 59" (150cm), 63" (160cm), 67" (170cm), 71" (180cm)

Threaded Shafts (6mm thread)
 • 17/64" (6.75 mm) Diameter - Lengths: 31" (79cm), 42" (106.5cm), 46" (117cm), 50" (127cm), 54" (137cm), 58" (147cm), 62" (157cm)
 • 9/32" (7.1mm) Diameter - Lengths: 31" (79cm), 42" (106.5cm), 46" (117cm), 50" (127cm), 54" (137cm), 58" (147cm), 62" (157cm), 66" (168cm)
 • 19/64" (7.5mm) Diameter - Lengths: 50" (127cm), 54" (137cm), 58" (147cm), 62" (157cm), 66" (168cm)

Large tabs standard on 9/32" (7.1mm) and 19/64" (7.5mm) shafts.

Mini and Large tabs available on all 9/32" (7.1mm) and 19/64" (7.5mm) Euroshafts. (Customer Preference)

17/64" (6.75mm) Large tab custom order



Flopper Shaft (Hawaiian)

19/64" (7.5mm) w/ large tabs (standard)

19/64" (7.5mm) w/ mini tabs

9/32" (7.1mm) w/ large tabs (standard)

9/32" (7.1mm) w/ mini tabs

17/64" (6.75mm) w/ mini tabs



NEW Tri-Cut Flopper Shaft (Tahitian)



Replacement Floppers, Barbs and Rivets available

SPEAR TIPS

RIFFE Ice Pick Slip Tip Assembly Used for shooting larger fish and helps prevent shaft bending and fish tearout. Unique milled pocket design keeps crimp level for a low profile, streamlined spear. Created for less resistance through the water while maintaining accuracy. Made from Heat Treated 17-4 PH Stainless Steel bar stock, machined on our state of the art CNC (Computer Numerical Controlled) Vertical Machining and Turning Centers. Anti-locking tapered Adapter.

Standard with new Tandem Slide Ring, a swedged stainless steel ball stop at the end of the cable enables the slide ring to exit the fish without hang up. Sub-Mini and Mini Ice Pick tip includes Nylon coated 485 lb. 1/16" (1.9 mm) Hi-Flex Coated Cable 7x19. Standard Ice Pick tip includes 500 lb. 1/16" (1.9mm) S.S. Coated Cable 7x7. Spectra line upgrade available.

Available sizes:

SUB Mini Ice Pick: 17/64"(6.75mm)(H-0010), 9/32"(7.1mm) (H-0011)

Mini Ice Pick: 17/64"(6.75mm)(H-1018), 9/32"(7.1mm)(H-1023), 19/64" (7.5mm) (H-1021), 5/16"(8mm) (H-1028),

Ice Pick Tip: 9/32"(7.1mm)(H-1022), 5/16"(8mm) 24" thrd (H-1015), 5/16"(8mm) 6mm thrd(H-1024), 11/32"(8.7mm) 24" thrd (H-1011), 3/8" (9.5mm) 24" thrd(H-1020)

6mm thread adapters for Mini Ice Pick.
6mm and 24 thread Adapters for Standard Ice Pick.

NEW Option to convert to Spectra on any Riffe Slip Tip (H-1015S)



Ice Pick Ring Line Assembly (H-1035) Used to maintain IcePick tension on the adapter and aids in removing spearhead from fish.



Sub-Mini Ice Pick Tip
9/32" (7.1mm)dia. x 3.25"(8.25cm)



Mini Ice Pick Tip
5/16" (8mm) dia. x 5"(12.7cm)



Standard Ice Pick Tip
3/8" (9.5mm) dia. x 5.5"(14 cm)



NEW Tri-Cut Mini Ice Pick Tip
5/16" (8mm) dia. x 5"(12.7cm)



NEW Tri-Cut Standard Ice Pick Tip
3/8" (9.5mm) dia. x 5.5"(14 cm)



Adapter



6mm (H-1033) & 24 thread (H-1030) Ice Pick Adapters (only)

Loop Slide Ring
Available sizes: 9/32"(7.1mm) (H1048), 5/16"(8mm) (H-1040), 11/32"(8.7mm) (H-1051), and 3/8"(9.5mm) (H-1045)



Tandem Slide Ring
Stainless Steel Tandem Slide Rings allow a shorter overhang on shaft. Featured on new Mini Ice Pick

Available sizes: 17/64"(6.75mm) (H-1047), 9/32"(7.1mm) (H-1049), 19/64"(7.5mm) (H-1038), 5/16"(8mm) (H-1041), 11/32"(8.7 mm) (H-1042) and 3/8"(9.5mm) (H-1046)



RIFFE Spear Tips
A. Small 2-barbed Tip Needle Point (6mm thread) - 5/16"(8mm) diameter (H-1000)
B. Medium 2-barbed Tip Needle Point (6mm thread) - 3/8"(9.5mm) diameter (H-1005)
C. Large 2-barbed Tip Quad Cut (5/16"-24 thread) - 7/16"(11mm) diameter (H-1010)
E. Ice Pick Slip Tip Assembly (5/16" -24 & 6mm thread adapters) (Seen on pg.26)
Available Slide Rings: 9/32"(7.1mm), 5/16"(8mm), 11/32"(9mm), 3/8"(9.5mm)

REELS & PARTS

Horizontal Reel - A low-profile design made of composite materials (Nylon-Fiberglass) including heat treated aluminum parts with a hard anodized surface. Featuring a clutch type drag with 4 positions activated by a lever on the side of the reel.

The spool size is the same as RIFFE's Vertical CFN REEL accepting up to 60 meters (200 ft) x 272 kg (600 lb.) Spectra Line. Mounts on all RIFFE spearguns as well as other manufactures that feature similar barrel shapes. Fits on flat and radial gun stocks with proper mounts.

Features:

- Light weight (9oz.)
- 4 Positions from Free Spool to Strong Drag
- Stainless Steel bail to prevent line tangle
- Assembled with 10-24 Screws for mounting on RIFFE Euro Series and other RIFFE models using threaded inserts or may be mounted with wood screws placed in a pre-drilled hole

Must specify Radial mount and if you need machine or wood screws, when ordering



Horizontal Reel - flat mount (RL-1500)
used on RIFFE Euro Series



Horizontal Reel - radial mount (RL-1500R)
Used on all RIFFE radiused barrel spearguns

Vertical Reel – Using the latest technology, Jay Riffe has designed a state of the art reel for the spearfishing industry. Made of injected glass filled Nylon for strength. Third generation RIFFE Reels since 1962.

Features:

- Light weight (8oz.)
- Large capacity, accepting up to 60 meters (200 ft) x 272 kg (600 lb) Spectra Line
- Automatic drag OUT / Free reeling IN
- On / Off drag lever for bail-out
- Tangle free / spool set-in back plate
- Corrosion resistance
- High impact strength



Vertical Reel (RL-1300)
used on all RIFFE radius barrel spearguns



Vertical Reel (RL-1310) shown with line



A. Reel Spring Ball Assembly (3) Horizontal (RL-1012)

B. Reel Drag Lever (Horizontal) (RL-1014)

C. Reel Drag Control Plate (Horizontal) (RL-1016)

D. Reel insert (Wood guns only) (2) Horizontal - installed (RL-1004H) (3) Vertical - installed (RL-1004) Sold individually (RL-1008)

E. Drag Rollers (RL-1005)

F. Reel Adapter Converter Kit (RL-1002) Used to convert a Horizontal Reel radial mount to a flat mount

G. Anodized Space Washers (3) (Vertical) (RL-1018)

H. REEL Spring Ball Assembly (3) (Vertical) (RL-1007)

I. Mounting Plate (Vertical) (RL-1019)

J. Spool & Knob Assembly (RL-1018) Knob Only (RL-1010)

K. On/Off Dial (Vertical) (RL-1003)

L. Nylocs Adjusting Nut (Vertical) (RL-1003)

M. Locking Nut (Vertical) (RL-1003)

N. Reel Axis Bolt (RL-1011)

O. Thrust Washer (RL-1011)

P. Teflon Washer (RL-1011)

Q. Bearing Tube Horizontal (RL-1025) Vertical (RL-1026)



SPEARGUN KITS



MACH 4 & 5

Blue Water Elite

Island Elite

Teak Maintenance



K-6000 (Teak)

K-6000P (Padauk)



K-6500 (Padauk)



Muzzle Reinforcement



Lead for Ballast Wing Kit
Small (KL-1000) Large (KL-1005)

MACH 4 & 5 Full Body Padauk Wings - Factory install only
 MACH4 Wings / MT4 Rear (K-4010)
 front width 1" (2.5cm), back width .5" (1.25cm), length 42" (107cm) (each wing)
 MACH5 Wings / MT5 Rear (K-4000)
 front width 1" (2.5cm), back width .5" (1.25cm), length 48" (122cm) (each wing)
 (No lead in wings)

Front Stabilizer Wing Kit (K-6000) teak and (K-6000P) padauk
 Designed to prevent muzzle kick up and improve accuracy at a distance on RIFFE mid handle spearguns. The front teak stabilizer aligns power bands parallel to the shaft for maximum power and adds balance and flotation. Primarily for Blue Water hunting. Now available in both Teak and Padauk.
 width 3" (2.5cm) (widest point), length 42" (107cm), thickness 1" (2.5cm) (each wing)

Padauk Elite Wings for Island and Blue Water Gun
 A stable platform which adds mass and lead ballast for larger blue water guns
 Island Elite Wing Kit (K-9500)
 front width 2.25" (5.7cm), back width 1.5" (3.8cm), length 45" (114cm) (each wing)
 Blue Water Elite Wing Kit (K-9000)
 front width 2.25" (5.7cm), back width 1.5" (3.8cm), length 51" (130cm) (each wing)

Rear Ballast Wing Kit (K-6500) teak (K-6500P) padauk
 Designed to reduce recoil and increase buoyancy on RIFFE Mid-handle spearguns. Lead optional. Do not recommend lead when using this wing on Metal Tech Series.
 width 2" (5cm) (widest point), length 20" (51cm), thickness 1.125" (2.9cm) (each wing)

** Mounting hardware included in all Wing Kits

Teak Maintenance Kit (TM-1000)
 Part 1 penetrating, part 2 laminating teak and padauk wood maintenance kit. Includes sand paper and instructions.

Bolted Muzzle Reinforcement Kit (K-7000) and (K-7050) (Euro series) Reinforces the muzzle when adding power. Recommended when using 4 bands. Comes standard on all Euro Series, #Island, #W Blue Water and #4 and #5 Standard Series.

SPEARGUN PARTS



- A.** Line Breakaway Assembly (L-6000)(Not used on Euro)
- B.** Line Breakaway Assembly (Bungee only) (L-6005)
- C.** 5" Bungee Shock Cord w/ Snap & Swivel w/680 lb. Nylon (L-6012) (Also used for Euro Breakaway)
- D.** 5" Bungee Shock Cord w/ Pigtail Swivel w/680 lb. Nylon (L-6010) (Also used for Euro Breakaway)
- E.** Butt End Assembly (B-1015R) (Euro)
- F.** Butt End Assembly (B-1015B) (Euro)
- G.** Butt End Assembly (B-1000)
- H.** Butt End Assembly (B-1005) (Competitor)
- I.** Velcro Strap (Gun Stock/bands) (L-4000)
- J.** Velcro Strap (Float Line) (L-4001)

- K.** Tip Protectors (H-4000)
- L.** Handle Assembly; Heavy Duty ABS Plastic (G-1000) (Competitor)
- M.** Handle Assembly Soft Grip; Heavy Duty reinforced glass filled Nylon handle with over molded cushion grip(G-1015) (Mid-Handle/Standard); (M-7040/M-7041) (Metal Tech Mid-handle/Metal Tech Rear handle)
- N.** Handle Assembly Soft Grip; Heavy Duty reinforced glass filled Nylon handle with over molded cushion grip(G-1020) (Euro)



Line Breakaway Assembly – Primarily used for blue water hunting with a float line bungee to surface float (L-6000)

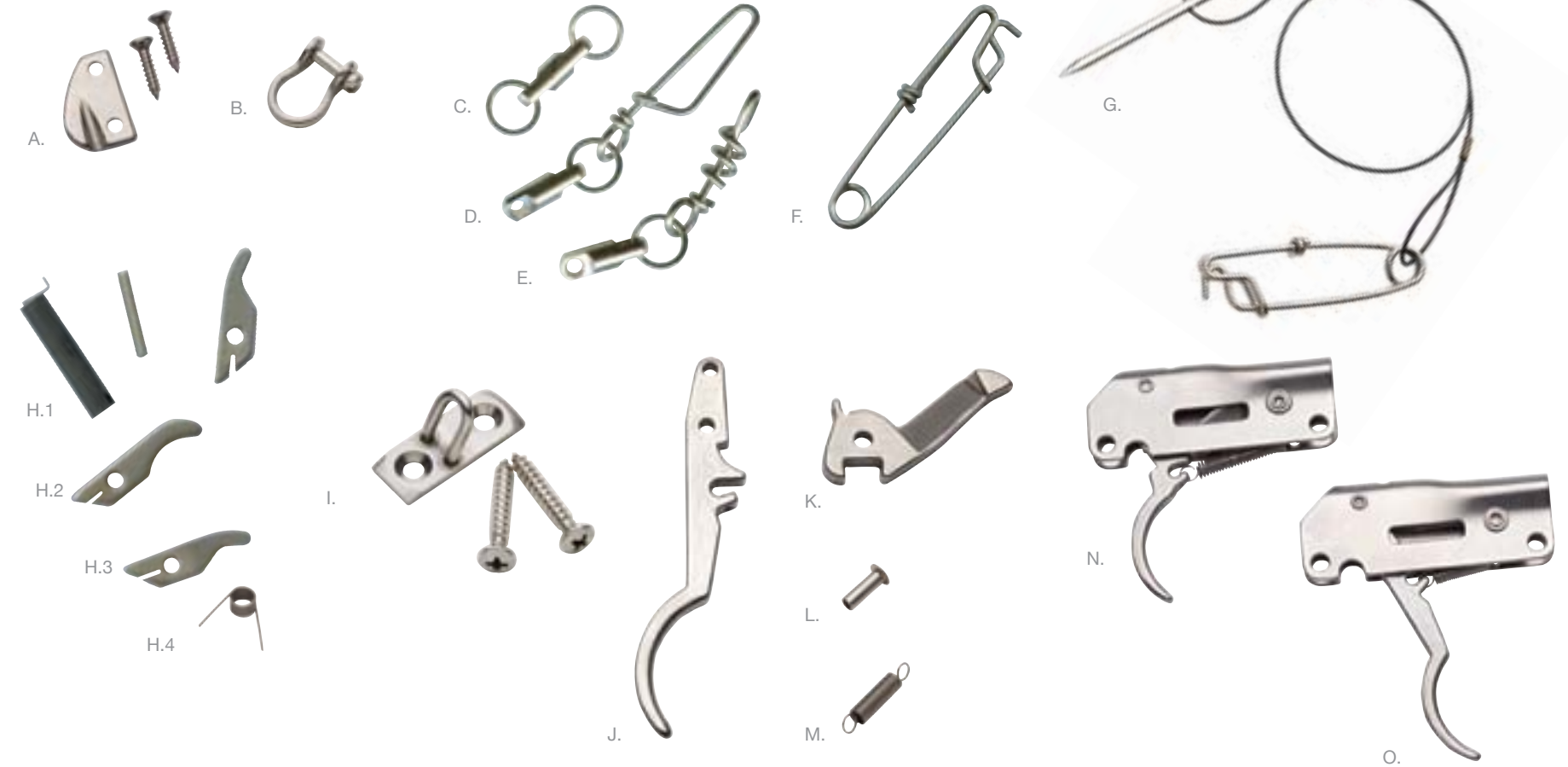

- A.** Front Line Guide Plate Assembly (A-1035)
- B.** Shackle (A-1000)
- C.** Ballbearing Swivel (A-1015)
- D.** Snap Swivel - 450lbs. (A-1022)
- E.** Pigtail Swivel - 550lbs. (A-1020)
- F.** Quick Clip (L-1020)
- G.** Fish Stringer & Quick Clip (S-1000)
- H.1.** Complete Line Release Assembly (D-1025) (Comps,#1-3 Standard, #B-N Mid Handle) (D-1026) (#1,#W,#4,#5,& Euro)
- H.2.** Line Release Assembly (D-1000)(#1,#W,#4,#5,& Euro)
- H.3.** Line Release Assembly (D-1005)(Comps,#1-3 Standard #B-N Mid Handle)
- H.4.** Line Release Spring Only (D-1010)
- I.** Line Anchor w/ Screws (A-1040)(Euro Series, A-1041)
- J.** Trigger (only) (T-1010)
- K.** Sear (T-1015)
- L.** Sear Rivet (T-1025), Trigger Rivet (T-1030)
- M.** Spring (T-1020)
- N.** Trigger Mechanism Assembly (T-2000) (Euro)
- O.** Trigger Mechanism Assembly (T-1000)

**All parts made from stainless steel



Euro Breakaway – When using line Breakaway assembly on Euro spearguns, move front 5" bungee to rear on shooting line. New 3' (.91m) longer line setup must be used. (L-6100)

POWER BANDS / SHOOTING LINE

RIFFE's Power Bands are made of "Gorilla Rubber", the highest modulus power band material available as tested. Contains antioxidants for longest life.

Available in sizes: 3/8" Diameter (9.5mm) for pole spear, 1/2" Diameter (13mm), 9/16" Diameter (14mm), 5/8" Diameter (16mm), 3/4" Diameter (19mm)



- A.** Black/Amber power band
- B.** Amber power band
- C.** Power bands available in bulk length
- D.** Waxed Nylon Tying Line (125 yard spool) (L-7010)
- E.** Dual sheath Spectra Wishbone (1000lb.) (3 pack)

Crimps: (10 per pack)

- F.** 1/16" 485/500/750 lb. Cable & 1000 lb. Spectra (L-5020)
- G.** 250/300 lb. Mono & 600 lb. Spectra (L-5005)
- H.** 400 lb. Mono (double sleeve) (L-5010)
- I.** 270 lb. Cable (double sleeve) (L-5000)

J. Crimping Tools; 1/16" 250/400 lb. Mono & Cable (L-5033), 3/64" 270 lb. Cable (L-5037)

J.1. Cable crimp shown used on Riffe Ice Pick Tip.



Shooting Line

- K.** 750 lb. (340kg) 5/64" (2mm) 7x7 S.S. Non-Coated Cable / 500 lb. (227kg) 1/16" (1.6mm) 7x7 S.S. Non-Coated Cable
 - L.** 500 lb. (227kg) 1/16" (1.6mm) - 3/32" (2.4mm) 7x7 S.S. Nylon Coated Cable or 485 lb. (218kg) 1/16" (1.6mm) - 3/32" (2.4mm) 7x19 Hi-Flex Nylon Coated Cable
 - M.** 270 lb. (122kg) 3/64" (1.2mm) - 1/16" (1.6mm) S.S. Nylon Coated Cable
 - N.** 400 lb. (182kg) Monofilament - 5/16" (8mm), 11/32" (8.7mm), 3/8" (9.5mm) shafts
 - O.** 300 lb. (136kg) Monofilament - 9/32" (7.1mm) & 5/16" (8mm) shafts
 - P.** 250 lb. (113kg) Monofilament - 17/64" (6.75mm) shafts.
- All shooting line is available in Bulk lengths



DIVING KNIVES

All RIFFE's knife blades are made with 420 heat-treated stainless steel, capable of cutting through Stainless Steel Cable, Monofilament, and High-Tech line. All RIFFE Knives are Teflon coated for corrosion resistance.

SPEARFISHER (RN-1000 & RNX-1000)

- 4.5" Blade
- 8.5" Overall length
- * Available in Standard or Deluxe

STUBBY (RN-2000 & RNX-2000)

- 3.5" Blade
- 7.5" Overall Length
- * Available in Standard or Deluxe

SILENCER (RN-3000)

- 4.5" Blade
- 9.5" Overall Length
- Self Locking with Sliding Safety
- Comes with rubber leg straps & lanyard

FILET (RN-4000)

- 7" flexible stainless steel blade.
- Teflon coated for cleaning and skinning fish.

TERMINATOR I & II (RN-6000 & RNX-6000)

- 4.5" Blade
- 9.5" Overall Length
- Self Locking
- * Available in Deluxe setup only

RN-6000 TERMINATOR I - single serration

RNX-6000 TERMINATOR II - dual serration

STUBBY TERMINATOR (RN-7000)

- 3.5" Blade
- 7.5" Overall length
- * Available in Deluxe setup only

* Standard - Rubber leg straps

* Deluxe - Rubber leg straps, forearm & leg stretch straps, & lanyard



RN-1000 (Featuring Standard Setup)



RN-6000 (Featuring Deluxe Setup)



Knife Accessories

1. Lanyard (RN-1005)
2. Forearm/Leg Stretch Straps (2) (RN-1006)
3. Rubber Knife Keeper (RN-1008)
4. a. Plastic Sheath - Terminator (RN-1012)
b. Plastic Sheath - Stubby Terminator (RN-1013)
c. Plastic Sheath - Spearfisher (RN-1009)
d. Plastic Sheath - Stubby (RN-1009)
e. Plastic Sheath - Silencer (RN-1010)





3 Atmosphere Float (F-1010)

The RIFFE 3 Atmosphere Torpedo Float designed to **maintain lift up to a maximum of 95 lbs at a depth of 66 ft and flotation beyond 100ft.** Pressurize up to 25 lbs PSI. The outer layer is made of a 320 lb./sq. vinyl coated tear strength material (22oz). Folds up to (14" x 14" x 2" = 4 lbs) for easy transporting. Inner replaceable urethane bladder has a reinforced 1000lb. Denier Cordova sleeve to maintain equal pressure throughout the bladder. Side zipper and (5) reinforced 1 1/2" Nylon buckle straps grant access to the inner replaceable urethane bladder. Soft lead may be added when using flag.

Special Features:

- **Inflated Dimensions - 39" length x 12" width x 11.75" height x 12" girth** • 33 Liter • Two side handles and one rear handle • Comes with emergency Flair holder (Flair not included) • Set up to use a flag & ballast weight of 3 lbs lead shot (flag & weight not included) • Comes standard with Air Pressure Gauge • BC Air Blower with adapters included • Suggested filling method: Orally inflate to fill volume of float, then complete with compressor or scuba tank • Safety orange color

The 3 Atmosphere Float is truly in a class of its own.

Torpedo 2 F-2011 and F-2013

Riffe's newest construction of the Torpedo Divers Float. The TORPEDO 2 float now offers **increased pressure limit up to 7 PSI with 95 lbs. of lift from the surface to 15 feet.** Top entry zipper allows ballast weight or internal bladder replacement. Compact/ideal for travel. Inflate by bicycle pump or preferable method – an air compressor found at your local gas station. **Be sure to always dive with a float!**

Special Features:

- 33 Liter • Depths below 15 feet will reduce lift capacity • Spring loaded valve • (2) side handles and (1) rear handle • Heavy Duty outer cover • Sandwich material with nylon in the middle • Non-staining material • 3 lb. lead shot bag – recommended when using flag assembly • Flare and flag holder

Optional pressure gauge plus adaptor for filling with either a bicycle pump, compressor, or scuba tank; flag and flag holder



Air Valve



Air blower adapter - shown with bicycle pump



Air gauge and air blower adapter included w/float

Utility Float F-1000

Stores in integrated compact roll, shown with quick clip. Fill orally or use CO2 Activator. 17lbs. (7.7kg) of lift at surface. 16gm (standard) cartridge included (may use 25gm, 38gm for deeper dives.) (Boater Safety Feature: For higher visibility, 3 lb. weight may be added to end pocket causing float to stand upright.)

CO2 Cartridge (16gm, 25gm, 38gm available)

FLOAT SYSTEMS

It's no secret BIG FISH are being caught with the aid of RIFFE's 3 Atmosphere Torpedo Float, Vinyl Float Line and Blue Water Bungee systems.

The Blue Water Hunter wants to make absolutely sure his prize fish and dinner doesn't get away. Our float lines keep fish connected to a float, allowing diver to resurface for another breath while fish fight the float.

So, what's so special about RIFFE's Vinyl float line and Blue Water Bungee?

RIFFE's Vinyl and Bungee Float Lines feature a 680lb (308kg) test Nylon core which offers exceptional strength and durability. Includes (2) stainless steel plugs, shackles and Quick Clips.

Our bungee stretches more than 2 1/2 times its length before reaching its static point. The super strong synthetic rubber is ozone, heat, and weather resistant for more stretch and durability.



Vinyl Float Line & Blue Water Bungee Assemblies

Used separately OR in combination. Both float lines are available in 25ft (7.6m), 50ft (15.2m), 75ft (22.9m), and 100ft (30.5m) lengths. The RIFFE bungee stretches 2 1/2 times its length with a 680lb (308kg) test Nylon line core (Black only). Blue Water Bungee Float Lines are not for use around sharp surfaces. *Vinyl Float lines available in Blue or Black*

Tag Line with Float (L-4025) (blue or black)

10ft. Tag Line with hard plastic float. Use in between two floats when hunting large pelagic fish, keeping lift capacity below 150 lbs for record application. Recommended for fish over 180 lbs (82 kilos).

Hard Float may be purchased separately

Armored Spectra Float Line

RIFFE's Armored Shock Absorbing Spectra Float Line features an inner float core of 6.35 mm closed cell neoprene for exceptional flotation and easy grip when under tension. The outer sheath is composed of 32 strands of Armored Spectra with a breaking strength in excess of 1100 pounds. Each strands' fibers are fused together and coated with molten polyethylene for an extreme abrasion and color-fast UV resistant protective sheath.

The new shock absorbing construction allows the line to stretch approximately 10% before locking in place, preventing the line from ripping out when sudden pressure is applied. Once pressure is released the line resumes its original length in a controlled manner, without snapping back.

Available lengths:
25 ft (7.6M), 50 ft (15.2M), 75 ft (22.8M), 100 ft (30.4M)



- A. Diver Down Flag (F-1014)
- B. International Diver Down Flag (F-1015)
- C. Flag Base (F-1016)
- D. Hard Plastic Float (small) Black (F-1019)
- E. Float Repair Cement (F-1017)



Diver: Paulo Afonso • MACH5
• Euro 130 rigged with reel & Breakaway assembly. 3ATM Float with bungee/Spectra floatline

SNORKELS

Stable SN-020

A low profile light weight snorkel with a flexible Vinyl tube, giving divers ability to fold up or stow in their BC. The dry top is shaped like a shark fin and reduces catch of line, seaweed and floating material

The RIFFE Stable snorkel comes with a high quality hinged snorkel keeper. It is the easiest clearing snorkel tested in our industry by freedivers. This Amazing snorkel is a true Fresh Air Snorkel.

Standard J SN-030

Large barrel Standard J snorkel with rotating silicone mouthpiece



Mask & Snorkel Accessories

1. Mask Strap MP-7007
2. Nylon Hinged Snorkel Keeper SP-7203
3. Stable Mouthpiece SP-7202
4. Standard J Mouthpiece SP-7201
5. Standard J Elbow SP-7209
6. Strap Retainer (2) MP-1231
7. Mask Buckles (2) MP-7010
8. Flexible Hose Stable SP-7214
9. Stable Body SP-7206
10. Stable Valve/Retainer SP-7204
11. Standard J Snorkel Keeper SP-7205



MASKS

We offer our customers a variety of low volume masks to fit numerous face shapes. Each mask is designed to give full support to the face by varying the thickness of silicone rubber and comes in a protective case.

All masks are made of heat treated silicone rubber to reduce fogging. Durable Nylon frame for superior strength. The plastic and silicone mold are of the highest quality and is evident when handling the mask.

- NEKTON - medium to wide faces
- MANTIS 5 - medium to wide faces
- MANTIS - medium to wide faces
- MANTIS LV - medium to wide faces
- VISO - narrow faces
- SIGHT - medium to wide faces
- NAIDA - fits a variety of medium to wide faces
- FRAMELESS - variety of face shapes
- COCO - smaller face shapes

3 Tempered glass lens options:

- CLEAR standard
- AMBER for increased light, higher contrast and better separation in low visibility
- MIRROR hides your eyes and reduces glare while hunting



Optical Lenses available for MANTIS, SIGHT, VISO & NAIDA starting at -1.0 up to -6.5 (custom lenses available upon request)



Kinugawa[®]
MADE IN JAPAN

NEKTON



Clear
MA-090

Amber
MA-091

Our lowest volume design, the **Nekton** is sleek and compact. Created with the freediver in mind. The low volume skirt is comfortable and form fitting, with a tear drop glass lens shape. This offers a wider vision span, allowing the diver to see more of their surroundings.

MANTIS 5



Clear
MA-010

Amber
MA-011

Mirror
MA-012

The **Mantis 5** has the same frame as our standard Mantis mask with a new low volume skirt offering 20 degrees more visibility. Fits *medium to wide* face shapes. Optical lenses available upon request.

MANTIS



Clear
MA-020

Amber
MA-021

Mirror
MA-022

A favorite for years, the **Mantis** mask has a comfortable fit offering a wide visible range. Fits *medium to wide* face shapes. Optical lenses available upon request.

MANTIS LV



Clear UV
MA-070

The **Mantis LV** features a coated UV Protective Film on a tempered unsymmetrical glass lens. This unique design offers the best view, both top and bottom as well as side to side. Includes drain channels for water evacuation below the eye. The Mantis LV fits so well preventing a ring on your face after use. Available in clear UV only.

SIGHT



Clear
MA-030

Amber
MA-031

Mirror
MA-032

The **Sight** has a low volume comfortable fitting skirt for *medium to wide* face shapes. Optical lenses available upon request.

VISO



Clear
MA-040

Amber
MA-041

Mirror
MA-042

The **Viso** has a low volume comfortable fitting skirt for the *narrow* face shapes sharing the same lens shape as the Naida. Optical lenses available upon request.

NAIDA



Clear
MA-050

Amber
MA-051

Mirror
MA-052

The **Naida** mask is a low volume, comfortable fitting mask for the *medium to wide* face shapes. Optical lenses available upon request.

COCO



Clear
MA-080

Amber
MA-081

The **Coco** mask offers a single lens fitting *medium to wide* face shapes.

FRAMELESS



Clear
MA-060



Amber
MA-061

The **Frameless** mask offers a single, non-replaceable lens and comfortable silicone skirt. Fits a *variety* of face shapes.

GO PRO Mask Mount

Don't miss out on capturing that amazing diving moment. Whether catching a prize fish, or swimming with dolphins, our mask mounts are sure to make you a hero among your peers.

Mantis / Mantis 5 (MA-GP01)
Naida (MA-GP02)
Nekton (MA-GP03)



MASK COMPARISON/SPECIFICATION CHART

MASK	VOLUME	FRAME LENGTH	FRAME HEIGHT
NEKTON	100ml	5.8in/147mm	3in/76mm
MANTIS 5	177ml	7.05in/179mm	3.35in/85mm
MANTIS	202ml	7.05in/179mm	3.35in/85mm
MANTIS LV	110ml	6.69in/170mm	3.27in/83mm
SIGHT	144ml	6.42in/163mm	2.75in/70mm
VISO	164ml	6.22in/158mm	2.75in/70mm
NAIDA	130ml	6.5in/165mm	2.75in/70mm
FRAMELESS	226ml	6.3in/150mm	3.35in/85mm
COCO	145ml	6.46in/164mm	3.19in/81mm



NEW RIFFE Composite Fiberglass Fins

- Three translucent camo designs: Digi-tek, Covi-tek, and Pelagi-tek
- 2 year warranty (under normal usage)
- Features large Fin Rails - radial design. Non-deforming with or without T-Rails.
- Foot rails help hold fin blade in foot pocket
- Water channeled efficiently across fin surface
- Diver may use with or without foot rails
- Foot pocket and blades also sold separately
- Compatible with variety of foot pocket brands

Silent Hunter Fins

The longest tapered high strength plastic fin blade manufactured. Longer blades store more energy and produce better spring action. Results in ease of kicking with less noise while hunting underwater. Side rails help channel water off the tip of the blade to prevent side wobble. The Silent Hunter Fin develops more forward thrust with less effort. Lower RPM - less noise for SILENT HUNTING.

Sizes

- Closed Heel Foot Pocket
- 40-42 (7.5 - 9)
 - 43-45 (9 - 11)
 - 46 - 48 (11 - 14)
- Optional Open Heel foot pocket
- size 46 - 48 (11 - 14) only



Warranty invalid if damage caused by misuse (jumping off boat with direct water impact, hitting propeller with fins, walking on rocks). Walking backwards towards ocean is recommended.



Digi-tek

Pelagi-tek

Covi-tek

Silent Hunter Fins

Fin Keepers

- Helps secure foot when using oversized fins
 - Eliminates noise
 - Prevents energy loss and sores
- Available Sizes: M,L,XL



Fin Keepers



Fin Keeper securing Foot Pocket



Optional Open Heel Foot Pocket



Closed Heel Foot Pocket



Side Rails

GLOVES, SOCKS, BELTS



3.5mm 3-D Fin Socks w/ non-skid sole

BT-05 (2mm), BT-06 (3.5mm)
Double sided, Bonded Nylon. Smooth interior for comfort, ease of entry and exit from sock. Extra durable outer material for wear. Flexible slip resistant tread. Sold in pairs.

Available Sizes: S, M, L, XL, and (2X-2mm only)
(left and right foot specific)



Reef Hunters Glove GL-01

2mm Nylon coated Neoprene non-slip diving gloves with reinforced Palms and fingers. A sensible choice for active hunters.

Available Sizes: XS, S, M, L, XL



Weight Belt WTB-1000

54" (137cm) flexible rubber weight belt may be adjusted by cutting to size. Inner horizontal ribbing prevents shifting while diving. Anti-corrosive glass filled Nylon cam-lock buckle with fast ditch capability. Weight capacity 20 lbs. Heavy duty Stainless Steel weight retainers available. Weight belt with 4 retainers WTB-1005

RIFFE'S NEW PELAGI-TEK AND COVI-TEK CAMO WETSUITS 1.5mm, 3.5mm, 5mm, & 7mm

The latest addition to the DIGI-TEK Camo family. RIFFE's NEW PELAGI-TEK and COVI-TEK are tailored toward blue water hunting and diving around rock and coral reefs, sandy bottoms, grass and kelp forests. Three different Camos that blend in any environment.

Yamamoto 100% CR (Chloroprene) Neoprene available. Outer 100% Impermeaflex lamination for 4 way stretch flexibility. Built in loading chest pad and reinforced knee pads. Comfortable, warm and flexible. Sizes XXS - 4XL

Features

1.5mm Steamer:

- One piece suit, non-hooded Steamer
- Japanese Yamamoto 100% CR Neoprene (Grade 39) – open cell
- Black Nylon inner lining (1.5mm only)
- Glued and blind stitched seams
- Slip resistant, cushioned loading chest pad
- High density screenprint knee/elbow protection
- Lycra binding on cuff and rubber seal around neck
- Back PK zipper with velcro zipper keeper
- Optional Lycra hood available

3.5mm, 5mm and 7mm 2-Piece Wetsuits: (Pelagi-tek 3.5mm only)

- Japanese Yamamoto 100% CR Neoprene (Grade 39) – open cell (3.5mm & 5mm)
- Face, wrist and ankle seals to prevent water entry
- Non binding wrist/ankle seams for more flexibility
- Slip resistant, cushioned loading chest pad
- High density screenprint knee protection
- Vented hood promotes excess air release
- 3.5mm High Waist Pant (non-titanium coated) – open cell
- 5mm Farmer John (non-titanium coated) – open cell
- 7mm Farmer John (Titanium coated) - open cell

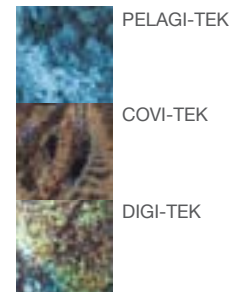

Model is 5'7"/185 lbs wearing a size L (54)



Model is 6'0"/175 lbs wearing a size L (54)



RIFFE DIGI-TEK CAMO WETSUITS 1.5mm, 3.5mm, 5mm, & 7mm

RIFFE DIGI-TEK digital camo wetsuits have proven to blend into most any ocean environment. Yamamoto 100% CR (Chloroprene) Neoprene with Impermeaflex lamination, for a lightweight, ultra flexible comfortable fit. Excellent heat retaining properties, quick drying. Sizes XXS - 4XL



Model is 6'1"/170 lbs wearing a size L (54)

Features

1.5mm STEAMER:

- One piece suit, non-hooded Steamer
- Yamamoto 100% CR Neoprene (Grade 39) – open cell
- Black Nylon inner lining
- Glued and blind stitched seams
- High density screenprint/cushioned chest pad
- High density screenprint knee protection
- Lycra binding on cuff and rubber seal around neck
- Back PK zipper with velcro zipper keeper
- Optional Lycra Hood available

3.5mm, 5mm and 7mm 2-Piece Wetsuits:

- Japanese Yamamoto 100% CR Neoprene (Grade 39) – open cell (3.5mm & 5mm)
- Face, wrist and ankle seals to prevent water entry
- Non binding wrist/ankle seams for more flexibility
- High density screenprint/cushioned chest pad
- High density screenprint knee protection
- Vented hood promotes excess air release
- 3.5mm High Waist Pant (non-titanium coated) – open cell
- 5mm Farmer John (non-titanium coated) – open cell
- 7mm Farmer John (Titanium coated) - open cell

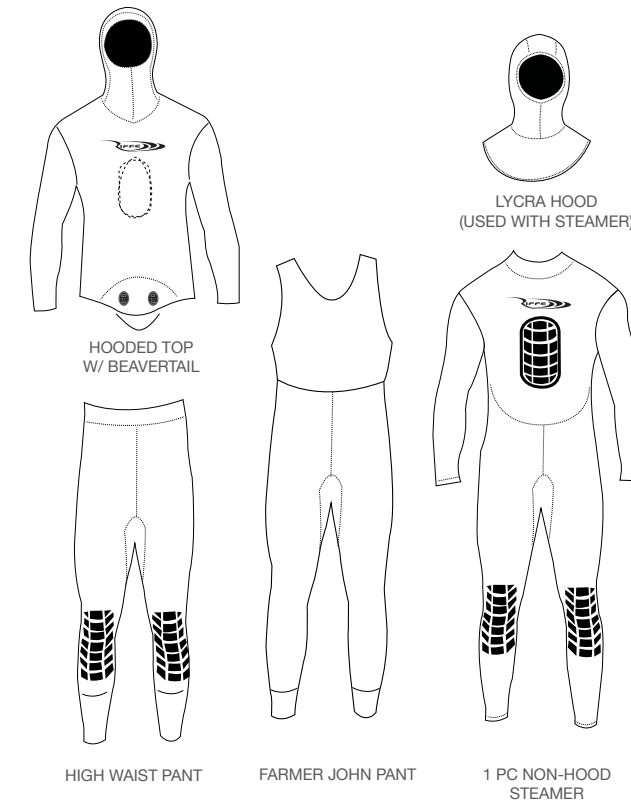

WETSUIT SIZE CHART			
US Size	Euro Size	Weight (lbs)	Height (feet/inch)
XXS	44	95-115	4'10" - 5'1"
XS	46	110-130	5' - 5'4"
S	48	125-150	5'3" - 5'7"
S-TALL	48-TALL	125-150	5'7" - 6' +
M	50	135-165	5'4" - 5'10"
M-TALL	50-TALL	135-165	5'10" - 6'2"+
ML	52	165-180	5'6" - 5'11"
ML-TALL	52-TALL	165-180	5'11" - 6'2"
L	54	170-180	5'7" - 6'1"
XL	56	180-200	5'8" - 6'3"
XXL	58	190-205	5'9" - 6'5"
XXXL	60	200-225	5'11" - 6'5"
XXXXL	62	215-240+	6' - 6'6"

Note: For best fit please provide customer's waist, coat, or shirt size and body build

LYCRAS / RASHGUARDS

2-PIECE LYCRA SUIT

Riffe's comfortable fitting Lycra Suit is made with a 4-way stretch Impermeaflex for diving tropical waters. Protects from the sun and jellyfish while blending in with nature's patterns.

Our Farmer John bottom includes added protection on the shins with flexible Lycra foot bands to prevent legs from slipping upward. Chest Loading pad on Hooded Top. Velcro connection at the padded beaver tail. Sizes S - 3XL

Features

- Heavy screenprint protection at elbows, buttocks, and shin
- Slip resistant, cushioned loading chest pad
- Velcro beaver tail closure
- Foot straps keep Lycra pant legs in place
- Wrist cuffs have thumb connectors to keep sleeves in place

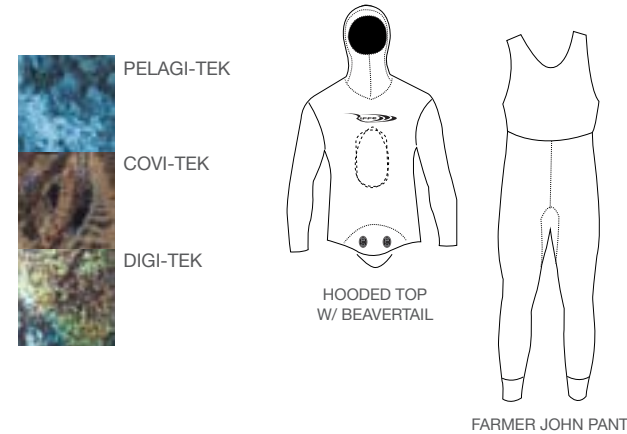

LYCRA HOODS - available in Pelagi-tek, Covi-tek, and Digi-tek camo



Model is 5'7"/185 lbs wearing a size L

Model is 5'10"/210 lbs wearing a size XL



Model is 5'7"/185 lbs wearing a size L



Model is 5'10"/210 lbs wearing a size XL

RASHGUARD

Comfortable fitting Lycra rashguards ideal for diving in tropical water. Protection from sun and jellyfish while blending in with nature's surroundings. Sizes: S - 3XL

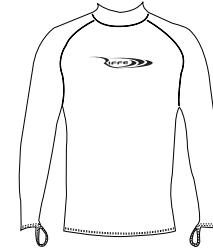

Features

- Raglan sleeve construction
- Thumb connectors at wrist cuffs to keep sleeves securely in place
- Heavy duty Impermeaflex fabric

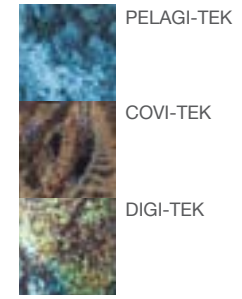

BAGS / TRAVEL CASES

NEW BUNKER 64" speargun case
THE BOSS 75" roller speargun case
 Supreme protection for your speargun.



Features:

- Unique adjustable "U" shaped Stock Keeper system holds speargun firmly in position
- Unique adjustable PVC Shaft Sleeve and End Caps
- Padded divider protects spearguns from other gear
- Internal MOLLE Line Management System (MLMS) w/ (2) Tension-Lock Shock Cords for secure line and tackle management
- 2 internal zippered pockets
- Outer pocket with MOLLE webbing for attaching compatible accessories
- 4 point shoulder strap for even weight distribution
- Closed Cell EVA foam padding
- Stainless Steel hardware (D-ring and clip)
- #10 and #8 YKK® corrosion resistant nylon zippers w/ antique nickel pull, Duraflex® TPR Pullers
- Fabric - 1680D Polyester PUx3, 420 Nylon PUx2 lining, 210 Nylon PUx2 divider. Durable Water Repellant (DWR) finish

Specs

BUNKER

Capacity 5280 cu in / 86.5 L
 Dimensions 64" (162.5 cm) x 11" (28cm) x 7.5" (19cm)

THE BOSS (Comes with wheel assembly)

Capacity 8250 cu in / 135 L
 Dimensions 75" (190.5 cm) x 11" (28cm) x 9.5" (24cm)

Internal Molle Secure Line Management System (MLMS) w/ (2) Tension-Lock Shock Cords

PVC Shaft Sleeve and End Caps

Adjustable Stock Keeper system

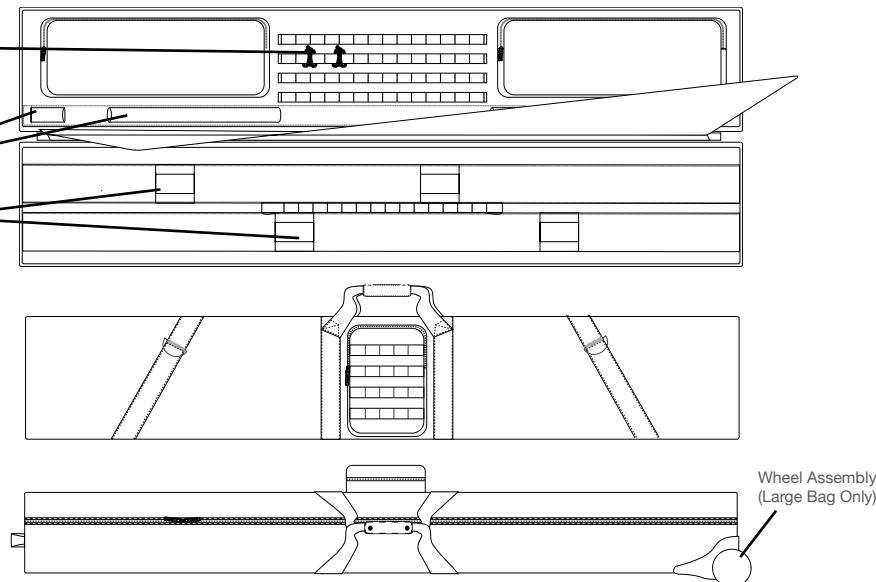

Wheel Assembly (Large Bag Only)

NEW DRIFTER Utility Pack
 The Ultimate Pack for your shore dive or daily treks.



Features:

- Speargun Stock Keeper with stow-able straps - holds up to (2) spearguns
- Exterior hypalon lined fin secure system
- Convertible floor system - may be removed to increase main compartment capacity
- Back panel access to mask/rig/tackle box (included) chamber with removable padded dividers for customized organizing
- Removable plastic rig/tackle case (included)
- Removable Lightweight Dry Bag (included)
- ITW Nexus® Safety Whistle Side/Release buckle
- Breathable mesh padded back panel
- 4 side organizer pockets
- Top tricot lined sunglass / cell phone hammock pocket
- Ergonomically contoured shoulder strap harness with adjustable sternum strap and ITW Nexus® Safety Whistle Side/Release buckle
- Top grab handle
- #10 and #8 YKK® corrosion resistant nylon zippers w/ antique nickel pull, Duraflex® TPR pullers
- Fabric - 450D Nylon Jacquard PUx2, 1680D Polyester PUx3, 210D Nylon PUx2 liner. Durable Water Repellant (DWR) finish

Specs

Capacity 2173.5 cu in / 35.6 L
 Dimensions 21" (53.4 cm) x 11.5" (29.2cm) x 9" (22.9cm)

Hypalon lined in secure system

Speargun Stock Keeper

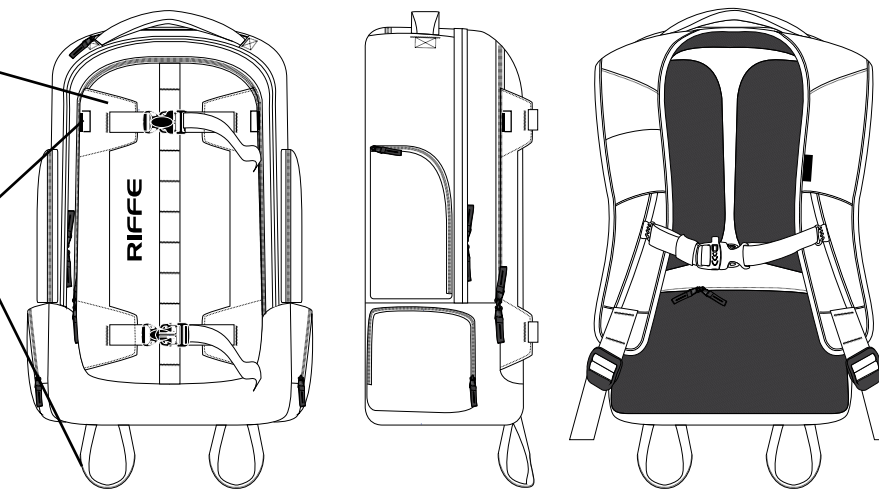

BAGS / TRAVEL CASES

NEW STOW Pole Spear Bag

Protect your pole spear investment. Padded 450 Nylon Jacquard bag. Hypalon end sheath keeps pole spear ends/tips secure and in place. Webbing system fastens pole spear sections



Features:

- MOLLE Line Management System (MLMS) secures and protects line and pole spear sections
- Inner zipper pouch holds tips/tools
- Hypalon reinforced sheath keeps pole spear end/tips protected
- Fabric - 450D Nylon Jacquard PUx2, 210D Poly liner. Durable Water Repellent (DWR) finish
- Padded body
- Locking zipper opens to lay flat

Specs

Capacity 24" 121.5 cu in., 36" 175.5 cu in., 48" 229.5 cu in.

Dimensions

27" (53.4 cm) x 5" (12.7cm)

39" (53.4 cm) x 5" (12.7cm)

51" (53.4 cm) x 5" (12.7cm)

(36" Pole spear bag shown above)

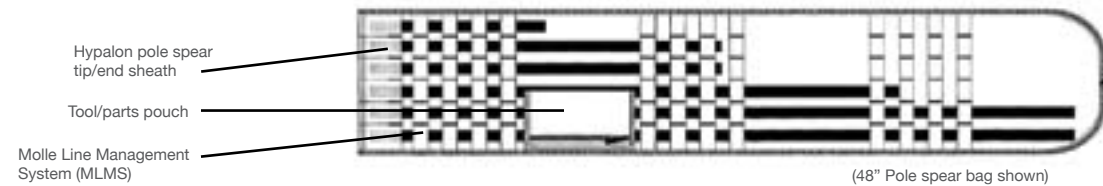

NEW TRAP Fin Bag

Ample space to hold a set of long blade fins and additional gear.



Features:

- Mesh panel for ventilation
- Outer pocket
- Removable shoulder strap with stainless steel hardware (D-ring and clip)
- Designed to fit Riffe's long blade fins and other dive gear
- Corrosion resistant nylon zippers w/ antique nickel pull
- Fabric - 450D Nylon Jacquard PUx2. Durable Water Repellent (DWR) finish

Specs

Capacity 3382.5 cu in / 55L

Dimensions 41" (104cm) x 7.5" (19cm) x 11" (28cm)



BAGS / TRAVEL CASES

NEW CASTOFF Roller Travel Bag



Features:

- 3 compartments separate gear from clothing
- Interior main compartment features side strap system to secure/stow fins; one against each sidewall, allowing for maximum utilization of space.
- Large interior mesh pocket
- Interior compression straps help secure load
- Padding at interior bottom protects fin blade ends
- Durable non corrosive YKK® nylon zippers with antique nickel zipper heads
- Duraflex® zipper pulls
- Large exterior pockets provide organization
- Full front compression straps with wings lash down fins or extra gear to bag
- Strong wheel assembly for a smooth, easy ride, skid plate and bars for durability
- Outer pocket with MOLLE webbing for attaching compatible accessories
- Durable Hypalon reinforced wear areas
- Fabric - 1680D Polyester PUx3, 210 Nylon PUx2, Durable Water Repellant (DWR) finish

Specs

Capacity 6956.7 cu in / 114 L
 Dimensions 42" (106.7 cm) x 15" (38cm) x 10/12" (25.4/30.5cm)(top/bottom)

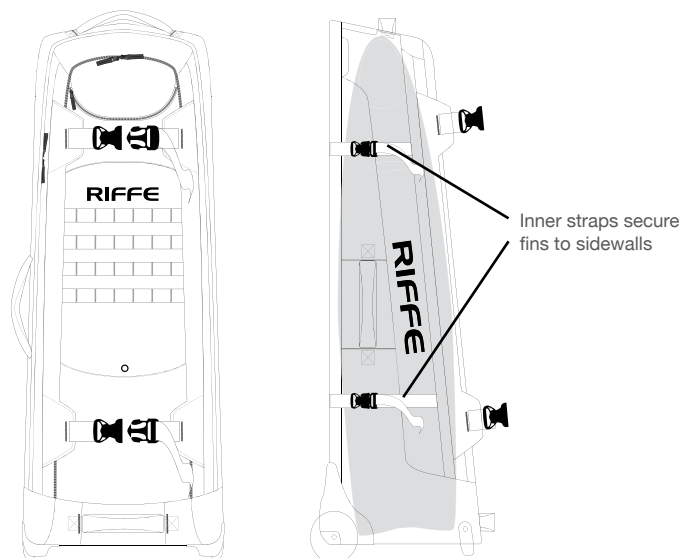

BUY APPAREL DIRECT ONLINE OR
 THROUGH YOUR LOCAL RIFFE DEALER
WWW.RIFFEAPPAREL.COM



BALLER D-BONE GUNNER ALL STAR



SHOOTER white s/s SUBMERGE



HUNTER CUDA SEEKER SEABASS



SHOOTER black s/s SHOOTER black l/s



YELLOWTAIL GROUPER MAHI GROUPER



RIFFE TEAM:

MARK HEALEY	RYDER DEVOE
KIMI WERNER	CRAIG CLASEN
BRANDON WAHLERS	JULIE RIFFE
RYAN MOORE	TIM MACDONALD
MICHAEL TAKACH	DJ STRUNTZ
JESSIE CRIPPS	GREG NORMAN JR.
PAULO AFONSO	JOHN DORNELLAS
SEBASTIAN MELANI	FORREST SIMON-DARIAS
DIEGO SANTIAGO	

*Photo credit:
DJ Struntz . Jessie Cripps . Michael Takach
Paulo Afonso . Ryan Moore . Mark Healey*

THANKS TO ALL FOR SHARING THE RIFFE LIFE !

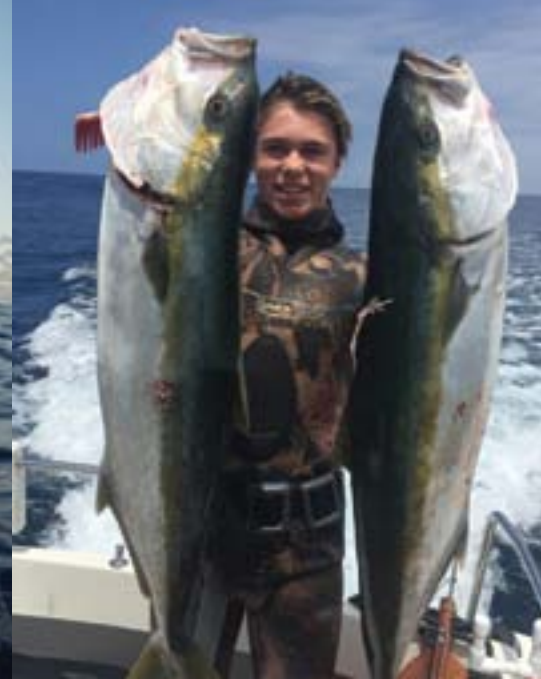

RIFFE SPEARFISHING TEAM

RIFFE

RIFFE INTERNATIONAL INC.

1214 Puerta Del Sol
San Clemente, CA 92673 USA
tel: (949) 361 2818
toll free: (800) 773 2748
fax: (949) 361 2885
email: info@speargun.com
speargun.com